

v5.0



WORKSPACE

INTELLIGENT WORKSPACES



Making offices  
make sense...

formetiq®

SALES@IQWORKSPACE.CO.UK | 01603 670 701 | WWW.IQWORKSPACE.CO.UK



**WORKSPACE**  
INTELLIGENT WORKSPACES

## WELCOME:

Refurbishing a workspace or office is a big decision for any company as it carries with it not only investment, but more often than not, it signals a change in direction in terms of aesthetics and environment.

Get it right, and a workforce becomes engaged, enthused and loyal. Get it wrong, and the disruption could prove costly. That's why we've developed a structured approach to all workspace refurbishment projects:

## THE BRIEF:

Any successful project is built on the foundations of knowledge. It's critical that we understand what makes your business tick, where you are now and where you want to be. Are you looking to expand? Make better use of your existing space? Increase efficiency or employee loyalty? With a firm grasp of the task at hand, we'll be in an ideal position to surpass your project expectations.

## VISUALISATION:

The design process is an exciting one, packed full of ideas, inspiration and possibilities. That's why, we like to involve our clients every step of the way, from conceptualisation through to delivery. You'll join us on the creative journey with regular check-ins at key design milestones to ensure we're on-brief.

## FURNITURE AND ACCESSORIES:

Successful, modern office environments usually have a common denominator...a flexible approach to office ergonomics. We've worked tirelessly to build partnerships with some of the biggest and best in the workspace sector to give our clients choice, value and above all, confidence that our diverse portfolio meets the exacting criteria of even the most discerning customer.

## IMPLEMENTATION:

Our fitters are manufacturer trained which is why each and every project is executed efficiently and correctly first-time, all the time. We appreciate the importance of a dependable partner, particularly when deadlines are tight, so our dedicated Account Managers will keep you apprised of the project status throughout whilst they coordinate with our fitters to ensure nothing is left to chance.

## DESKING & PEDESTALS

VERSA BENCH DESKING SYSTEM	04
VERSA SLIDING TOP DESK SYSTEM	10
VERSA CABLE MANAGEMENT OPTIONS	12
VERSA LEG STYLE OPTIONS	13
VERSA WOOD	14
VERSA CONFERENCE TABLES	24
VERSA SYSTEM STORAGE	26
ELECTRA HEIGHT ADJUSTABLE DESKS	28
ALTO HEIGHT ADJUSTABLE DESKS	29
SALO SIT/STAND DESK SYSTEM	30
OPTO EXTRA CANTILEVER WORKSTATIONS	34
OPTO PANEL LEG DESKS	38
MFC PEDESTALS & DESK HEIGHT STORAGE	40

## CONFERENCE & MEETING TABLES

MEDIA WALL UNITS	42
RATIO MEETING TABLES	43
OPTO MEETING, TRAINING & CONFERENCE TABLES	44
BREAKOUT TABLES	50
DISQUS CONFERENCE TABLES	51

## CUPBOARDS & STORAGE

COMBO STORAGE	52
SELECT STORAGE	60
SELECT STORAGE LOCKERS	68

## RECEPTION DESKS

CURVE RECEPTION DESKS	72
VERSA RECEPTION DESKS	73

## EXECUTIVE FURNITURE

STOCKHOLM EXECUTIVE FURNITURE	74
-------------------------------	----

## SCREENS & ACOUSTIC PRODUCTS

PERSPEX DESKTOP SCREENS & MODESTY PANELS	78
FABRIC DESKTOP SCREENS	80
HUSHH ACOUSTIC DESK SCREENS & MODESTY PANELS	82
HUSHH FREE STANDING ACOUSTIC SCREENS	84
HUSHH MEETING POD	86

## CHAIRS

TASK & OPERATOR CHAIRS	88
MEETING & VISITOR CHAIRS	92
BREAKOUT CHAIRS	94
STACKABLE MEETING CHAIRS	96
LOUNGE SEATING	98

## COMPUTER ACCESSORIES & CABLE MANAGEMENT

MONITOR ARMS	102
I-STAND SIT-STAND DESK CONVERSION KITS	106
SIT-STAND MATS	108
STEEL PEDESTALS	110
CPU HOLDERS	112
CABLE MANAGEMENT	114
POWER AND DATA MODULES	115

## FINISH OPTIONS

WOOD & METAL FINISHES	120
VERSACOLOUR™ PERSPEX® COLOUR OPTIONS	121
FABRIC OPTIONS	122
FINISH AVAILABILITY OPTIONS CHART	126

# VERSA BENCH DESKING SYSTEM

To find out more and request a quote, visit our website [formetiq.com](http://formetiq.com)

Beauty in simplicity. Versa combines clean and minimal aesthetics with great functionality.

The Versa shared leg system keeps costs and assembly time down to a minimum.

Prices shown are for goal post (U) Legs; Angled (A) and Loop (O) Legs are +£4 per single desk and +£24 per back-to-back bench (see page 13).



## Single Desks



### 600mm Deep Single Desks (+£14 for A/O Legs)

Code	Size (mm)	Group 1 Price (£)	Group 2 Price (£)
DNA124	w1200 d600 h740	224	242
DNA144	w1400 d600 h740	238	261



### 700mm Deep Single Desks

Code	Size (mm)	Group 1 Price (£)	Group 2 Price (£)
DNA122	w1200 d700 h740	247	270
DNA142	w1400 d700 h740	252	275
DNA162	w1600 d700 h740	266	294
DNA182	w1800 d700 h740	322	350



### 800mm Deep Single Desks

Code	Size (mm)	Group 1 Price (£)	Group 2 Price (£)
DNA120	w1200 d800 h740	266	289
DNA140	w1400 d800 h740	270	289
DNA160	w1600 d800 h740	289	312
DNA180	w1800 d800 h740	308	336

## Single Desks with Scoop



### 700mm Deep Single Desks with Scoop Back

Code	Size (mm)	Group 1 Price (£)	Group 2 Price (£)
DNA126	w1200 d700 h740	266	289
DNA146	w1400 d700 h740	266	284
DNA166	w1600 d700 h740	275	298
DNA186	w1800 d700 h740	322	350



### 800mm Deep Single Desks with Scoop Back

Code	Size (mm)	Group 1 Price (£)	Group 2 Price (£)
DNA125	w1200 d800 h740	266	294
DNA145	w1400 d800 h740	284	298
DNA165	w1600 d800 h740	298	326
DNA185	w1800 d800 h740	322	354

# VERSA BENCH DESKING SYSTEM

## Single Desks with Central Cable Flap

Includes Cable Flap CPM3213



### 700mm Deep Single Desks with Central Cable Flap

Code	Size (mm)	Group 1 Price (£)	Group 2 Price (£)
DNA123	w1200 d700 h740	274	297
DNA143	w1400 d700 h740	293	311
DNA163	w1600 d700 h740	302	325
DNA183	w1800 d700 h740	349	377



### 800mm Deep Single Desks with Central Cable Flap

Code	Size (mm)	Group 1 Price (£)	Group 2 Price (£)
DNA121	w1200 d800 h740	293	316
DNA141	w1400 d800 h740	311	325
DNA161	w1600 d800 h740	325	353
DNA181	w1800 d800 h740	349	381

## Extension for In-line Bench



### 700mm Deep Extension for In-line Bench

Code	Size (mm)	Group 1 Price (£)	Group 2 Price (£)
DND12C	w1200 d700 h740	245	268
DND14C	w1400 d700 h740	251	274
DND16C	w1600 d700 h740	264	292
DND18C	w1800 d700 h740	320	348



### 800mm Deep Extension for In-line Bench

Code	Size (mm)	Group 1 Price (£)	Group 2 Price (£)
DND12A	w1200 d800 h740	224	247
DND14A	w1400 d800 h740	228	247
DND16A	w1600 d800 h740	247	270
DND18A	w1800 d800 h740	266	294

## Extension for In-line Bench with Scoops



### 700mm Deep Extension for In-line Bench with Scoop Backs

Code	Size (mm)	Group 1 Price (£)	Group 2 Price (£)
DND12E	w1200 d700 h740	264	287
DND14E	w1400 d700 h740	264	282
DND16E	w1600 d700 h740	273	296
DND18E	w1800 d700 h740	320	348

Continued on next page





# VERSA BENCH DESKING SYSTEM

Extension for In-line Bench with Scoops  
(Continued)



### 800mm Deep Extension for In-line Bench with Scoop Backs

Code	Size (mm)	Group 1 Price (\$)	Group 2 Price (\$)
DND128	w1200 d800 h740	224	252
DND148	w1400 d800 h740	242	256
DND168	w1600 d800 h740	256	284
DND188	w1800 d800 h740	280	312

Extension for In-line Bench with Central Cable Flap



### 700mm Deep Extension for In-line Bench with Cable Flaps

Code	Size (mm)	Group 1 Price (\$)	Group 2 Price (\$)
DND12D	w1200 d700 h740	272	295
DND14D	w1400 d700 h740	291	309
DND16D	w1600 d700 h740	300	323
DND18D	w1800 d700 h740	347	374

Includes cable flap CPM3213



### 800mm Deep Extension for In-line Bench with Cable Flaps

Code	Size (mm)	Group 1 Price (\$)	Group 2 Price (\$)
DND12B	w1200 d800 h740	251	274
DND14B	w1400 d800 h740	269	283
DND16B	w1600 d800 h740	283	311
DND18B	w1800 d800 h740	307	339

2 Desk Back-to-Back Bench



### 1440mm Deep 2 Desk Back-to-Back Bench

Code	Size (mm)	Group 1 Price (\$)	Group 2 Price (\$)
DNS123	w1200 d1440 h740	406	452
DNS143	w1400 d1440 h740	415	462
DNS163	w1600 d1440 h740	443	499
DNS183	w1800 d1440 h740	555	611



### 1640mm Deep 2 Desk Back-to-Back Bench

Code	Size (mm)	Group 1 Price (\$)	Group 2 Price (\$)
DNS122	w1200 d1640 h740	438	485
DNS142	w1400 d1640 h740	448	485
DNS162	w1600 d1640 h740	485	532
DNS182	w1800 d1640 h740	522	578

2 Desk Back-to-Back Bench with Scoops



### 1440mm Deep 2 Desk Back-to-Back Bench with Scoop Backs

Code	Size (mm)	Group 1 Price (\$)	Group 2 Price (\$)
DNS127	w1200 d1440 h740	443	490
DNS147	w1400 d1440 h740	443	480
DNS167	w1600 d1440 h740	462	508
DNS187	w1800 d1440 h740	555	611



### 1640mm Deep 2 Desk Back-to-Back Bench with Scoop Backs

Code	Size (mm)	Group 1 Price (\$)	Group 2 Price (\$)
DNS126	w1200 d1640 h740	438	494
DNS146	w1400 d1640 h740	476	504
DNS166	w1600 d1640 h740	504	560
DNS186	w1800 d1640 h740	550	616

# VERSA BENCH DESKING SYSTEM

2 Desk Back-to-Back Bench with Central Cable Flaps



Includes cable flap CPM3213



### 1440mm 2 Desk Back-to-Back Bench with Cable Flaps

Code	Size (mm)	Group 1 Price (\$)	Group 2 Price (\$)
DNS125	w1200 d1440 h740	460	506
DNS145	w1400 d1440 h740	497	534
DNS165	w1600 d1440 h740	516	562
DNS185	w1800 d1440 h740	609	665



Extension for Back-to-Back Bench



### 1640mm 2 Desk Back-to-Back Bench with Cable Flaps

Code	Size (mm)	Group 1 Price (\$)	Group 2 Price (\$)
DNS124	w1200 d1640 h740	492	539
DNS144	w1400 d1640 h740	529	557
DNS164	w1600 d1640 h740	557	613
DNS184	w1800 d1640 h740	604	669

### 1440mm Deep Extension for Back-to-Back Bench

Code	Size (mm)	Group 1 Price (\$)	Group 2 Price (\$)
DND123	w1200 d1440 h740	373	420
DND143	w1400 d1440 h740	382	429
DND163	w1600 d1440 h740	410	466
DND183	w1800 d1440 h740	528	578

### 1640mm Deep Extension for Back-to-Back Bench

Code	Size (mm)	Group 1 Price (\$)	Group 2 Price (\$)
DND122	w1200 d1640 h740	401	448
DND142	w1400 d1640 h740	410	448
DND162	w1600 d1640 h740	448	494
DND182	w1800 d1640 h740	485	541

Extension for Back-to-Back Bench with Scoops



### 1440mm Extension for Back-to-Back Bench with Scoop Backs

Code	Size (mm)	Group 1 Price (\$)	Group 2 Price (\$)
DND129	w1200 d1440 h740	410	457
DND149	w1400 d1440 h740	410	448
DND169	w1600 d1440 h740	429	476
DND189	w1800 d1440 h740	522	578



### 1640mm Extension for Back-to-Back Bench with Scoop Backs

Code	Size (mm)	Group 1 Price (\$)	Group 2 Price (\$)
DND127	w1200 d1640 h740	401	457
DND147	w1400 d1640 h740	438	466
DND167	w1600 d1640 h740	466	522
DND187	w1800 d1640 h740	513	578

Extension for Back-to-Back Bench with Cable Flaps



### 1440mm Extension for Back-to-Back Bench with Cable Flaps

Code	Size (mm)	Group 1 Price (\$)	Group 2 Price (\$)
DND125	w1200 d1440 h740	427	474
DND145	w1400 d1440 h740	464	502
DND165	w1600 d1440 h740	483	529
DND185	w1800 d1440 h740	576	632

Continued on next page...



# VERSA BENCH DESKING SYSTEM

Extension for Back-to-Back Bench with Cable Flaps  
(Continued)



1640mm extension for Back-to-Back Bench with Cable Flaps

Code	Size (mm)	Group 1 Price (\$)	Group 2 Price (\$)
DND124	w1200 d1640 h740	455	502
DND144	w1400 d1640 h740	492	520
DND164	w1600 d1640 h740	520	576
DND184	w1800 d1640 h740	567	632

Full Width End Desk Extension with Scoop



End desk extension with scoop for Back-to-Back Bench

Code	Size (mm)	Group 1 Price (\$)	Group 2 Price (\$)
SP-DNA146	w1440 d700 h740	375	423
SP-DNA165	w1640 d800 h740	395	445

\*Includes joining plates to attach to main bench

Desk Extensions



Extension Units

Code	Size (mm)	Group 1 Price (\$)	Group 2 Price (\$)
DNC080	w800 d600 h740	131	145
DNC060	w600 d800 h740	145	163
DNC141	w1440 d600 h740	149	163
DNC161	w1640 d600 h740	159	177

Crescent Desks



Crescent Desks LH & RH (No Cable Ports or Scoops)

Code	Size (mm)	Group 1 Price (\$)	Group 2 Price (\$)
DNL140	w1400 d1200 h740	350	382
DNL160	w1600 d1200 h740	359	392
DNL180	w1800 d1200 h740	378	410
DNR140	w1400 d1200 h740	350	382
DNR160	w1600 d1200 h740	359	392
DNR180	w1800 d1200 h740	378	410

Crescent Desks LH & RH with Cable Flap CPM3213



Code	Size (mm)	Group 1 Price (\$)	Group 2 Price (\$)
DNL141	w1400 d1200 h740	358	391
DNL161	w1600 d1200 h740	372	319
DNL181	w1800 d1200 h740	423	461
DNR141	w1400 d1200 h740	358	391
DNR161	w1600 d1200 h740	372	419
DNR181	w1800 d1200 h740	423	461

120° Desks



Cluster of 3 120° Desks with Scoop Backs

Code	Size (mm)	Group 1 Price (\$)	Group 2 Price (\$)
DNS128	ø2810 h740	1138	1250

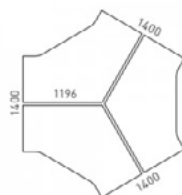

# VERSA BENCH DESKING SYSTEM

'O' Leg Panel Inserts



Panel Inserts for 'O' Leg Benches

Code	Size (mm)	Group 1 Price (\$)	Group 2 Price (\$)
DNZ102	w1336 d1336 h595	149	159
DNZ101	w1536 d1536 h595	168	173

DNZ102 for 1440mm bench  
DNZ101 for 1640mm bench

Coffee Tables



Coffee Tables

Code	Size (mm)	Group 1 Price (\$)	Group 2 Price (\$)
CNN060	w600 d600 h400	145	154
CNN120	w1200 d600 h400	187	196

Cabinets



Cabinets with Pull-out Drawer

Code	RH/LH	Size (mm)	Group 1 Price (\$)	Group 2 Price (\$)
DNE217	RH	w402 d800 h740	562	592
DNE218	LH	w402 d800 h740	562	592
DNE314	UNI	w400 d800 h1090	766	881
DNE315	RH	w400 d800 h1200	783	898
DNE316	LH	w400 d800 h1200	783	898

Lockable, 3 Shelves, Includes Pen Tray (Not DNE314)

Pedestals



3 Standard Drawers Mobile Castors

Code	Size (mm)	Group 1 Price (\$)	Group 2 Price (\$)
DNF633	w298 d600 h560	217	255

3 Standard Drawers Mobile Castors

Code	Size (mm)	Group 1 Price (\$)	Group 2 Price (\$)
DNF632	w428 d600 h560	230	264

1 Standard Drawer 1 Filing Drawer Mobile Castors

Code	Size (mm)	Group 1 Price (\$)	Group 2 Price (\$)
DNF627	w298 d600 h560	238	281

1 Standard Drawer 1 Filing Drawer Mobile Castors

Code	Size (mm)	Group 1 Price (\$)	Group 2 Price (\$)
DNF626	w428 d600 h560	251	289

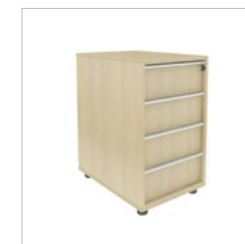

4 Standard Drawers Desk Height With Feet

Code	Size (mm)	Group 1 Price (\$)	Group 2 Price (\$)
DNF642	w430 d600 h740	294	332

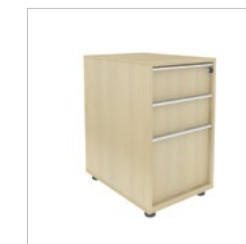

2 Standard Drawers 1 Filing Drawer Desk Height With Feet

Code	Size (mm)	Group 1 Price (\$)	Group 2 Price (\$)
DNF636	w430 d600 h740	307	358



2 Standard Drawers Fixed Pedestal

Code	Size (mm)	Group 1 Price (\$)	Group 2 Price (\$)
DNF422	w428 d600 h410	175	204

Please see page 12 for cable trays. Other pedestal options also available.

## VERSA SLIDING TOP DESK SYSTEM

A complete range of sliding desktops to complement the Versa Bench Desking Range.

Sliding desktop options complement the Versa Bench Desking Range. Available as single or back-to-back desks on 1400mm and 1600mm wide tops, making access to under desk cable trays simple and easy.

Prices shown are for goal post (U) legs. Angled (A) and loop (O) legs are +£4 per single desk and +£24 for back-to-back bench desks.

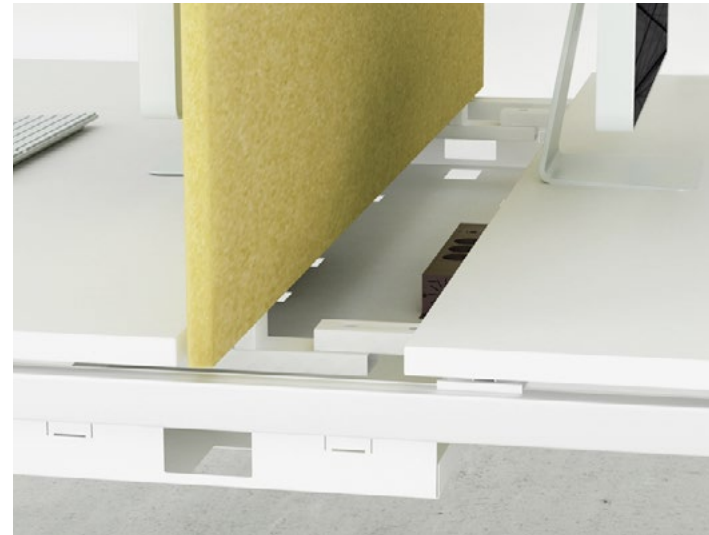

Desk with Sliding Desktop



### 700mm Deep Single Desk with Sliding Desktop

Code	Size (mm)			Group 1 Price (£)	Group 2 Price (£)
DNA151	w1400	d700	h740	289	312
DNA171	w1600	d700	h740	303	326



### 700mm Deep Single Desk with Sliding Scoop Back Desktop

Code	Size (mm)			Group 1 Price (£)	Group 2 Price (£)
DNA152	w1400	d700	h740	298	326
DNA172	w1600	d700	h740	312	336



### 800mm Deep Single Desk with Sliding Desktop

Code	Size (mm)			Group 1 Price (£)	Group 2 Price (£)
DNA153	w1400	d800	h740	308	331
DNA173	w1600	d800	h740	322	345



### 800mm Deep Single Desk with Sliding Scoop Back Desktop

Code	Size (mm)			Group 1 Price (£)	Group 2 Price (£)
DNA154	w1400	d800	h740	317	340
DNA174	w1600	d800	h740	331	359

Desk Bench with Sliding Desktop



### 1440mm Deep 2 Desk Bench with Sliding Desktop

Code	Size (mm)			Group 1 Price (£)	Group 2 Price (£)
DNS150	w1400	d1440	h740	489	536
DNS170	w1600	d1440	h740	517	564

## VERSA SLIDING TOP DESK SYSTEM

Desk Bench with Sliding Desktop (continued)



### 1440mm Deep 2 Desk Bench with Sliding Scoop Back Desktop

Code	Size (mm)			Group 1 Price (£)	Group 2 Price (£)
DNS151	w1400	d1440	h740	508	564
DNS171	w1600	d1440	h740	536	583



### 1640mm Deep 2 Desk Bench with Sliding Desktop

Code	Size (mm)			Group 1 Price (£)	Group 2 Price (£)
DNS152	w1400	d1640	h740	522	569
DNS172	w1600	d1640	h740	550	597



### 1640mm Deep 2 Desk Bench with Sliding Scoop Back Desktop

Code	Size (mm)			Group 1 Price (£)	Group 2 Price (£)
DNS153	w1400	d1640	h740	541	587
DNS173	w1600	d1640	h740	569	624

Supplementary units for Double Benches



### 1440mm Supplementary Unit with Sliding Desktop

Code	Size (mm)			Group 1 Price (£)	Group 2 Price (£)
DND152	w1400	d1440	h740	457	504
DND172	w1600	d1440	h740	485	532



### 1440mm Supplementary Unit with Sliding Scoop Back Desktop

Code	Size (mm)			Group 1 Price (£)	Group 2 Price (£)
DND153	w1400	d1440	h740	476	532
DND173	w1600	d1440	h740	504	550



### 1640mm Supplementary Unit with Sliding Desktop

Code	Size (mm)			Group 1 Price (£)	Group 2 Price (£)
DND154	w1400	d1640	h740	485	532
DND174	w1600	d1640	h740	513	560



### 1640mm Supplementary Unit with Sliding Scoop Back Desktop

Code	Size (mm)			Group 1 Price (£)	Group 2 Price (£)
DND155	w1400	d1640	h740	504	550
DND175	w1600	d1640	h740	532	588



# VERSA MODESTY PANELS & CABLE MANAGEMENT

Versa MFC Modesty Panels



### Versa Modesty Panels (Top hung including brackets)

Code	Size (mm)	For Desk Width (mm)	Group 1 Price (£)	Group 2 Price (£)
DNH120	h350	1200	28	33
DNH140	h350	1400	33	37
DNH160	h350	1600	37	42
DNH180	h350	1800	42	47
DNH200	h350	2000	47	51

Cable Trays - Modesty Fix



### Cable Trays - Modesty Fix

Code	Size (mm)	For Desk Width (mm)	Price (£)
DZZ102	w630 d70 h50	1000	28
CTM085	w850 d70 h50	1200	30
CTM105	w1050 d70 h50	1400	35
CTM125	w1250 d70 h50	1600	39
CTM145	w1450 d70 h50	1800	45

Cable Trays - Desktop Fix



### Cable Trays - Desktop Fix

Code	Size (mm)	For Desk Width (mm)	Price (£)
DZZ101	w630 d90 h90	1000	32
CTD085	w850 d90 h90	1200	32
CTD105	w1050 d90 h90	1400	37
CTD125	w1250 d90 h90	1600	42
CTD145	w1450 d90 h90	1800	48

Shared Cable Trays for Bench Desking

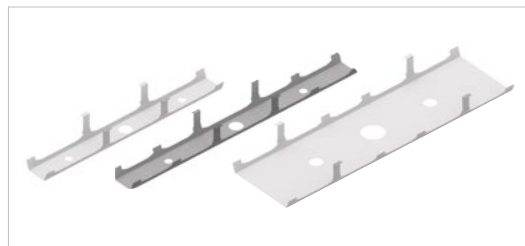

### Shared Cable Trays for Bench Desking

Code	Size (mm)	For Desk Width (mm)	Price (£)
CTS110	w1100 d110 h130	1200/1400	51
CTS140	w1400 d110 h130	1600/1800	69
CTW110	w1100 d430 h130	1200/1400	94
CTW140	w1400 d430 h130	1600/1800	116

Cable Trays for Versa Sliding Top Desks



### Cable Trays for Versa Sliding Top Desks

Code	Size (mm)	For Desk Width (mm)	Price (£)
DNZ024	w1316 d146 h96	1400	71
DNZ025	w1516 d146 h96	1600	71
CTWH110	w1100 d430 h130	1400	99
CTWH140	w1400 d430 h130	1600	125

Cable Management



VCS1 Vertical Cable Manager - Silver, White or Black

Code	Size (mm)	Price (£)
VCS1	w75 d35 h1200	29



VCS2 Vertical Cable Manager - Silver, White or Black

Code	Size (mm)	Price (£)
VCS2	Ø70 h720 - 820	35



VCS3 Large Vertical Cable Manager for Sit/Stand Desks - Black only

Code	Size (mm)	Price (£)
VCS3	w68 d36 h1300	45



Snap Wrap Cable Manager for Sit/Stand Desks - Silver, White or Black

Code	Size (mm)	Price (£)
VCS080 & VCS150	h800 - h1500	67
	800mm (VCS080)	67
	1500mm (VCS150)	109

# VERSA LEG STYLE OPTIONS

Straight Leg Frame System



Angled Leg Frame System

+£4 per single desk or +£24 for back-to-back bench



Loop Leg Frame System

+£4 per single desk or +£24 for back-to-back bench



Loop Leg Frame System with Panel Insert

See page 9 for leg insert panels





# VERSA WOOD BENCH DESKING SYSTEM

## Versa Wood MFC top desks.

The Versa Wooden leg desk range features solid wooden legs that are lacquered and stained in a natural ash finish, with metal inserts for assembly and hidden height levelling feet.

The desks are easy to install with metal-to-metal fixings and only require one tool for assembly.



### Single Desks



**700mm Deep Single Desk with Straight Back**

Code	Size (mm)	Group 1 Price (\$)	Group 2 Price (\$)
DNA122-W	w1200 d700 h740	518	541
DNA142-W	w1400 d700 h740	522	546
DNA162-W	w1600 d700 h740	536	564



**700mm Deep Single Desk with Cable Flap**

Code	Size (mm)	Group 1 Price (\$)	Group 2 Price (\$)
DNA123-W	w1200 d700 h740	545	568
DNA143-W	w1400 d700 h740	563	582
DNA163-W	w1600 d700 h740	573	596



**700mm Deep Single Desk with Scoop for Cable Management**

Code	Size (mm)	Group 1 Price (\$)	Group 2 Price (\$)
DNA126-W	w1200 d700 h740	536	560
DNA146-W	w1400 d700 h740	536	555
DNA166-W	w1600 d700 h740	546	569



**800mm Deep Single Desk with Straight Back**

Code	Size (mm)	Group 1 Price (\$)	Group 2 Price (\$)
DNA120-W	w1200 d800 h740	546	569
DNA140-W	w1400 d800 h740	550	569
DNA160-W	w1600 d800 h740	569	592
DNA180-W	w1800 d800 h740	588	616



**800mm Deep Single Desk with Cable Flap**

Code	Size (mm)	Group 1 Price (\$)	Group 2 Price (\$)
DNA121-W	w1200 d800 h740	573	596
DNA141-W	w1400 d800 h740	591	605
DNA161-W	w1600 d800 h740	605	633
DNA181-W	w1800 d800 h740	628	655

# VERSA WOOD BENCH DESKING SYSTEM

### Single Desks (Continued)



**800mm Deep Single Desk with Scoop for Cable Management**

Code	Size (mm)	Group 1 Price (\$)	Group 2 Price (\$)
DNA125-W	w1200 d800 h740	546	574
DNA145-W	w1400 d800 h740	564	578
DNA165-W	w1600 d800 h740	578	606
DNA185-W	w1800 d800 h740	602	634

### Back to Back Benches



**1440mm Deep 2 Desk Bench with Straight Tops**

Code	Size (mm)	Group 1 Price (\$)	Group 2 Price (\$)
DNS123-W	w1200 d1440 h740	802	849
DNS143-W	w1400 d1440 h740	811	858
DNS163-W	w1600 d1440 h740	839	895



**1440mm Deep 2 Desk Bench with Cable Flaps**

Code	Size (mm)	Group 1 Price (\$)	Group 2 Price (\$)
DNS125-W	w1200 d1440 h740	856	903
DNS145-W	w1400 d1440 h740	893	931
DNS165-W	w1600 d1440 h740	912	958



**1440mm Deep 2 Desk Bench with Scoops for Cable Management**

Code	Size (mm)	Group 1 Price (\$)	Group 2 Price (\$)
DNS127-W	w1200 d1440 h740	839	886
DNS147-W	w1400 d1440 h740	839	877
DNS167-W	w1600 d1440 h740	858	905



**1640mm Deep 2 Desk Bench with Straight Tops**

Code	Size (mm)	Group 1 Price (\$)	Group 2 Price (\$)
DNS122-W	w1200 d1640 h740	867	914
DNS142-W	w1400 d1640 h740	877	914
DNS162-W	w1600 d1640 h740	914	961
DNS182-W	w1800 d1640 h740	951	1007



**1640mm Deep 2 Desk Bench with Cable Flaps**

Code	Size (mm)	Group 1 Price (\$)	Group 2 Price (\$)
DNS124-W	w1200 d1640 h740	921	968
DNS144-W	w1400 d1640 h740	958	986
DNS164-W	w1600 d1640 h740	986	1042
DNS184-W	w1800 d1640 h740	1033	1098



**1640mm Deep 2 Desk Bench with Scoops for Cable Management**

Code	Size (mm)	Group 1 Price (\$)	Group 2 Price (\$)
DNS126-W	w1200 d1640 h740	867	923
DNS146-W	w1400 d1640 h740	905	933
DNS166-W	w1600 d1640 h740	621	933
DNS186-W	w1800 d1640 h740	979	1044

# VERSA WOOD BENCH DESKING SYSTEM

Back to Back Bench Extension



**1440mm Deep Extension for 2-Desk bench with Straight Tops**

Code	Size (mm)	Group 1 Price (\$)	Group 2 Price (\$)
DND123-W	w1200 d1440 h740	494	541
DND143-W	w1400 d1440 h740	504	550
DND163-W	w1600 d1440 h740	532	588



**1440mm Deep Extension for 2-Desk bench with Cable Flaps**

Code	Size (mm)	Group 1 Price (\$)	Group 2 Price (\$)
DND125-W	w1200 d1440 h740	548	595
DND145-W	w1400 d1440 h740	585	623
DND165-W	w1600 d1440 h740	604	651



**1440mm Deep Extension for 2-Desk bench with Scoops for Cable Management**

Code	Size (mm)	Group 1 Price (\$)	Group 2 Price (\$)
DND129-W	w1200 d1440 h740	532	578
DND149-W	w1400 d1440 h740	532	569
DND169-W	w1600 d1440 h740	550	597



**1640mm Deep Extension for 2-Desk bench with Straight Tops**

Code	Size (mm)	Group 1 Price (\$)	Group 2 Price (\$)
DND122-W	w1200 d1640 h740	532	578
DND142-W	w1400 d1640 h740	541	578
DND162-W	w1600 d1640 h740	578	625
DND182-W	w1800 d1640 h740	616	671



**1640mm Deep Extension for 2-Desk bench with Cable Flaps**

Code	Size (mm)	Group 1 Price (\$)	Group 2 Price (\$)
DND124-W	w1200 d1640 h740	585	632
DND144-W	w1400 d1640 h740	623	651
DND164-W	w1600 d1640 h740	651	707
DND184-W	w1800 d1640 h740	697	763



**1640mm Deep Extension for 2-Desk bench with Scoops for Cable Management**

Code	Size (mm)	Group 1 Price (\$)	Group 2 Price (\$)
DND127-W	w1200 d1640 h740	532	588
DND147-W	w1400 d1640 h740	569	597
DND167-W	w1600 d1640 h740	597	653
DND187-W	w1800 d1640 h740	643	709

# VERSA WOOD TABLES

Meeting Tables



**1200mm Deep Meeting Table for 4 or 6 seats, with or without central wood insert strip with cable grommet**

Code	Size (mm)	Wood Insert	Group 1 Price (\$)	Group 2 Price (\$)
CNM121-W	L1200 d1200 h740	No	597	616
CNM181-W	L1800 d1200 h740	No	653	681
CNM123-W	L1200 d1200 h740	Yes	685	755
CNM183-W	L1800 d1200 h740	Yes	765	853



**1200mm Deep Meeting Table for 8 or 10 Seats**

Code	Size (mm)	Group 1 Price (\$)	Group 2 Price (\$)
CNM240-W	L2400 d1200 h740	947	984
CNM281-W	L2800 d1200 h740	965	1021



**1200mm Deep Meeting Table for 8 or 10 Seats with central wood insert strips with cable grommets**

Code	Size (mm)	Group 1 Price (\$)	Group 2 Price (\$)
CNM242-W	L2400 d1200 h740	1124	1264
CNM283-W	L2800 d1200 h740	1180	1301

Breakout Tables



**700mm Round/Square Coffee Table**

Code	Size (mm)	Group 1 Price (\$)	Group 2 Price (\$)
CNN070-W	Ø700 h480	219	238
CNN071-W	w700 d700 h480	270	289



**700mm Deep High Table**

Code	Size (mm)	Group 1 Price (\$)	Group 2 Price (\$)
CNM166-W	w1600 d700 h1050	816	835
CNM18A-W	w1800 d700 h1050	820	853





# VERSA WOOD CHAMFERED EDGE BENCH DESKING SYSTEM

Versawood laminate top chamfered edge desks.

The high pressure laminate tops feature a sloped underside edge that tapers from 26mm to 11mm, portraying a sharp, delicate edge that is softened by 77mm radius corners and inset legs.

Chamfered laminate tops are available in all white, all black or white tops with black underside. Wooden legs in natural ash finish.



Single Desks with Chamfered Edge



700mm Deep Chamfered Top Single Desk with Straight Back

Code	Size (mm)	Group 1 Price (\$)	Group 2 Price (\$)
DNA14E-W	w1400 d700 h740	634	919
DNA16E-W	w1600 d700 h740	657	984

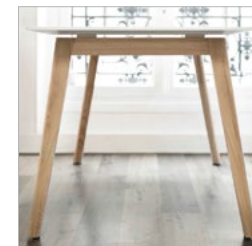

700mm Deep Chamfered Top Single Desk with Cable Flap

Code	Size (mm)	Group 1 Price (\$)	Group 2 Price (\$)
DNA14F-W	w1400 d700 h740	670	933
DNA16F-W	w1600 d700 h740	694	1003

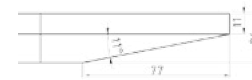

The chamfered edge is on the underside of the table and is 77mm deep. It tapers from 26mm to 11mm thin at the table edge.



700mm Deep Chamfered Top Single Desk with Scoop for Cable Management

Code	Size (mm)	Group 1 Price (\$)	Group 2 Price (\$)
DNA14G-W	w1400 d700 h740	643	933
DNA16G-W	w1600 d700 h740	667	1003

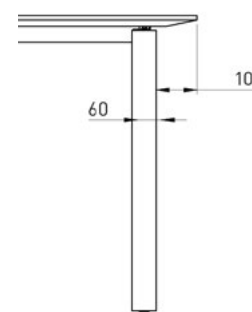

Legs for chamfered edge desks are inset by 103mm



800mm Deep Chamfered Top Single Desk with Straight Back

Code	Size (mm)	Group 1 Price (\$)	Group 2 Price (\$)
DNA14H-W	w1400 d800 h740	671	998
DNA16H-W	w1600 d800 h740	699	1072
DNA18A-W	w1800 d800 h740	741	1156



800mm Deep Chamfered Top Single Desk with Cut-Out for Cable Port

Code	Size (mm)	Group 1 Price (\$)	Group 2 Price (\$)
DNA14I-W	w1400 d800 h740	703	1012
DNA16I-W	w1600 d800 h740	731	1019
DNA18B-W	w1800 d800 h740	773	1184

# VERSA WOOD CHAMFERED EDGE BENCH DESKING SYSTEM

Single Desks with Chamfered Edge (Continued)



800mm Deep Chamfered Top Single Desk with Scoop for Cable Management

Code	Size (mm)	Group 1 Price (\$)	Group 2 Price (\$)
DNA14J-W	w1400 d800 h740	676	1012
DNA16J-W	w1600 d800 h740	704	1091
DNA18C-W	w1800 d800 h740	746	1184

Chamfered Edge Back to Back Benches



1440mm Deep 2 Desk Chamfered Top Bench with Straight Tops

Code	Size (mm)	Group 1 Price (\$)	Group 2 Price (\$)
DNS14F-W	w1400 d1440 h740	1017	1595
DNS16F-W	w1600 d1440 h740	1072	1716



1440mm Deep 2 Desk Chamfered Top Bench with Cable Flaps

Code	Size (mm)	Group 1 Price (\$)	Group 2 Price (\$)
DNS14G-W	w1400 d1440 h740	1089	1623
DNS16G-W	w1600 d1440 h740	1136	1763



1440mm Deep 2 Desk Chamfered Top Bench with Scoops for Cable Management

Code	Size (mm)	Group 1 Price (\$)	Group 2 Price (\$)
DNS14H-W	w1400 d1440 h740	1035	1623
DNS16H-W	w1600 d1440 h740	1082	1763



1640mm Deep 2 Desk Chamfered Top Bench with Straight Tops

Code	Size (mm)	Group 1 Price (\$)	Group 2 Price (\$)
DNS14C-W	w1400 d1640 h740	1110	1753
DNS16C-W	w1600 d1640 h740	1156	1902
DNS18C-W	w1800 d1640 h740	1240	2080



1640mm Deep 2 Desk Chamfered Top Bench Cable Flaps

Code	Size (mm)	Group 1 Price (\$)	Group 2 Price (\$)
DNS14D-W	w1400 d1640 h740	1173	1800
DNS16D-W	w1600 d1640 h740	1229	1940
DNS18D-W	w1800 d1640 h740	1313	2117



1640mm Deep 2 Desk Chamfered Top Bench with Scoops for Cable Management

Code	Size (mm)	Group 1 Price (\$)	Group 2 Price (\$)
DNS14E-W	w1400 d1640 h740	1119	1800
DNS16E-W	w1600 d1640 h740	1175	1940
DNS18E-W	w1800 d1640 h740	1259	2117



# VERSA WOOD CHAMFERED EDGE BENCH DESKING SYSTEM

Chamfered Edge Back to Back Benches



**1440mm Deep 4 Desk Chamfered Top Bench with Straight Tops**

Code	Size (mm)	Group 1 Price (\$)	Group 2 Price (\$)
DNS280-W	w2800 d1440 h740	1688	2546
DNS320-W	w3200 d1440 h740	1837	2826



**1440mm Deep 4 Desk Chamfered Top Bench with Cable Flaps**

Code	Size (mm)	Group 1 Price (\$)	Group 2 Price (\$)
DNS281-W	w2800 d1440 h740	1814	2602
DNS321-W	w3200 d1440 h740	1945	2826



**1440mm Deep 4 Desk Chamfered Top Bench with Scoops for Cable Management**

Code	Size (mm)	Group 1 Price (\$)	Group 2 Price (\$)
DNS282-W	w2800 d1440 h740	1707	2602
DNS322-W	w3200 d1440 h740	1837	2826



**1640mm Deep 4 Desk Chamfered Top Bench with Straight Tops**

Code	Size (mm)	Group 1 Price (\$)	Group 2 Price (\$)
DNS283-W	w2800 d1640 h740	1828	2798
DNS323-W	w3200 d1640 h740	1996	3133
DNS360-W	w3600 d1640 h740	2126	3413



**1640mm Deep 4 Desk Chamfered Top Bench with Cable Flaps**

Code	Size (mm)	Group 1 Price (\$)	Group 2 Price (\$)
DNS284-W	w2800 d1640 h740	1973	2854
DNS324-W	w3200 d1640 h740	2103	3133
DNS361-W	w3600 d1640 h740	2234	3413



**1640mm Deep 4 Desk Chamfered Top Bench with Scoops for Cable Management**

Code	Size (mm)	Group 1 Price (\$)	Group 2 Price (\$)
DNS285-W	w2800 d1640 h740	1865	2854
DNS325-W	w3200 d1640 h740	1996	3133
DNS362-W	w3600 d1640 h740	2126	3413

# VERSA WOOD CHAMFERED EDGE BENCH DESKING SYSTEM

1440mm Deep Chamfered Edge Back to Back Bench Extension

Note:

Extensions units on this page can only be added to 4-desk benches on page 20.

Please see diagram on page 23 for further information.



**1440mm Deep Extension with Straight Tops for 4-Desk Bench with Chamfered Edges**

Code	Size (mm)	Group 1 Price (\$)	Group 2 Price (\$)
DND140-W	w1400 d1440 h740	699	1119
DND160-W	w1600 d1440 h740	765	1250



**1440mm Deep Extension with Cable Flaps for 4-Desk Bench with Chamfered Edges**

Code	Size (mm)	Group 1 Price (\$)	Group 2 Price (\$)
DND141-W	w1400 d1440 h740	763	1147
DND161-W	w1600 d1440 h740	837	1278



**1440mm Deep Extension with Scoops for 4-Desk Bench with Chamfered Edges**

Code	Size (mm)	Group 1 Price (\$)	Group 2 Price (\$)
DND146-W	w1400 d1440 h740	709	1147
DND166-W	w1600 d1440 h740	783	1278

1640mm Deep Chamfered Edge Back to Back Bench Extension



**1640mm Deep Extension with Straight Tops for 2-Desk Bench with Chamfered Edges**

Code	Size (mm)	Group 1 Price (\$)	Group 2 Price (\$)
DND148-W	w1200 d1640 h740	746	1240
DND168-W	w1400 d1640 h740	821	1371
DND180-W	w1600 d1640 h740	914	1567



**1640mm Deep Extension with Cable Flaps for 2-Desk Bench with Chamfered Edges**

Code	Size (mm)	Group 1 Price (\$)	Group 2 Price (\$)
DND14A-W	w1200 d1640 h740	819	1259
DND16A-W	w1400 d1640 h740	893	1418
DND181-W	w1600 d1640 h740	914	1567



**1640mm Deep Extension with Scoops for 2-Desk Bench with Chamfered Edges**

Code	Size (mm)	Group 1 Price (\$)	Group 2 Price (\$)
DND14B-W	w1200 d1640 h740	765	1259
DND16B-W	w1400 d1640 h740	839	1418
DND183-W	w1600 d1640 h740	914	1567

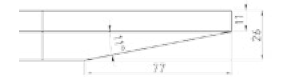
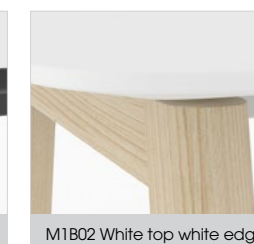

The edge has a 77mm chamfer tapering from 26mm to 11mm thin at the table edge.

# VERSA WOOD CHAMFERED EDGE TABLES

## Chamfered Edge Back Meeting Tables



1200mm Deep Meeting Table with 1 Piece Chamfered Edge Top, with or without central wood insert strip with cable grommet

Code	Size (mm)	Wood Insert	Group 1 Price (\$)	Group 2 Price (\$)
CNM124-W	L1200 d1200 h740	No	783	1203
CNM184-W	L1800 d1200 h740	No	928	1044
CNM126-W	L1200 d1200 h740	Yes	877	1250
CNM186-W	L1800 d1200 h740	Yes	1054	1613

1200mm Deep Meeting Table with Chamfered Edge Top for 8 or 10 Seats

Code	Size (mm)	Group 1 Price (\$)	Group 2 Price (\$)
CNM243-W	L2400 d1200 h740	1320	2150
CNM284-W	L2800 d1200 h740	1422	2392

1200mm Deep Meeting Table with Chamfered Edge Top for 8 or 10 Seats with central wood insert strips with cable grommets

Code	Size (mm)	Group 1 Price (\$)	Group 2 Price (\$)
CNM245-W	L2400 d1200 h740	1506	2271
CNM286-W	L2800 d1200 h740	1595	2471

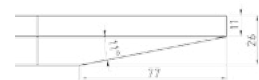

The chamfered edge is on the underside of the table and is 77mm deep. It tapers from 26mm to 11mm thin at the table edge.



## Chamfered Edge Breakout Tables

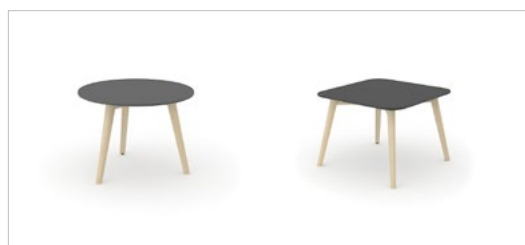

700mm Round/Square Coffee Table with Chamfered Top

Code	Size (mm)	Group 1 Price (\$)	Group 2 Price (\$)
CNN072-W	Ø700 h480	270	410
CNN073-W	w700 d700 h480	331	476

700mm Deep High Table with Chamfered Top

Code	Size (mm)	Group 1 Price (\$)	Group 2 Price (\$)
CNM167-W	w1600 d700 h1050	947	1273
CNM189-W	w1800 d700 h1050	998	1362



# VERSA WOOD SIZING INFORMATION

Sizing information for Versa wood straight edge desks.

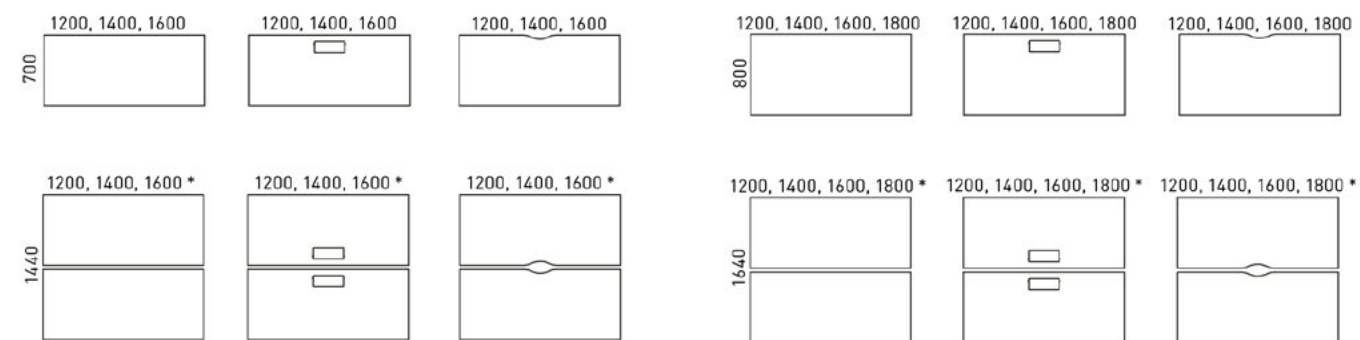

Sizing information for Versa wood desks with chamfered edges.

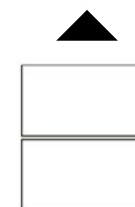
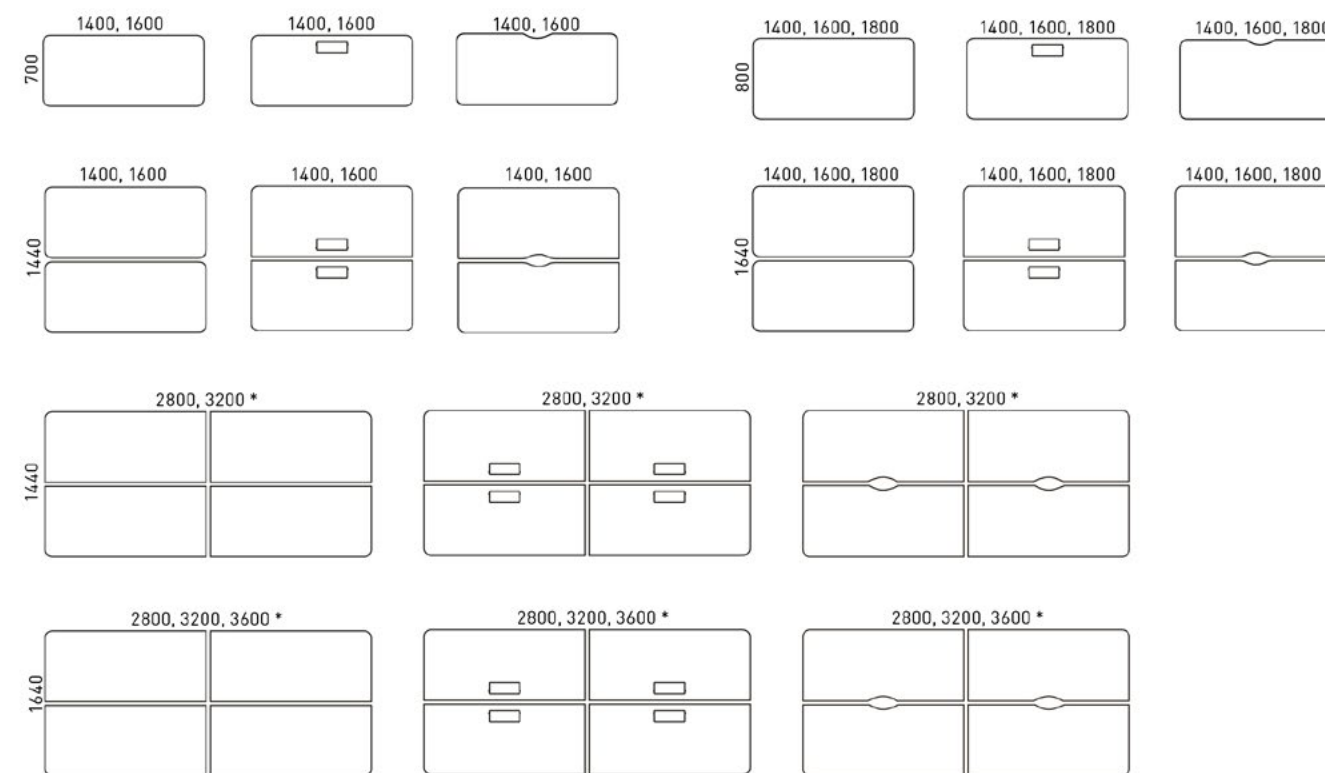

Extension units (p21) fit in-between bench desk units (p20) to extend the bench.



# VERSA CONFERENCE TABLES

## Conference Tables

Veneer finishes also available - POA.

Please note - on two piece table tops it is not possible to match the grain on the join where the tops meet



### Square Table

Code	Size (mm)	Group 1 Price (\$)	Group 2 Price (\$)
CNM080	L800 w800 h740	224	242
CNM120	L1200 w1200 h740	350	378



### 1000mm Deep Desk / Table (1 piece top)

Code	Size (mm)	Group 1 Price (\$)	Group 2 Price (\$)
SP-BNA140	L1400 w1000 h740	335	POA
SP-BNA160	L1600 w1000 h740	365	POA
BNA180	L1800 w1000 h740	354	387
BNA200	L2000 w1000 h740	368	401
SP-BNA240	L2400 w1000 h740	636	POA



### 1000mm Deep Long Meeting Tables (2 piece top)

Code	Size (mm)	Group 1 Price (\$)	Group 2 Price (\$)
SP-BNA280	L2800 w1000 h740	698	POA
SP-BNA320	L3200 w1000 h740	758	POA
SP-BNA360	L3600 w1000 h740	737	POA
SP-BNA400	L4000 w1000 h740	765	POA



### 1200mm Deep Desk / Table (1 piece top)

Code	Size (mm)	Group 1 Price (\$)	Group 2 Price (\$)
CNM120	L1200 w1200 h740	350	378
SP-CNM140	L1400 w1200 h740	375	POA
SP-CNM160	L1600 w1200 h740	436	POA
SP-CNM180	L1800 w1200 h740	461	POA
SP-CNM200	L2000 w1200 h740	481	POA
SP-CNM240	L2400 w1200 h740	676	POA



### 1200mm Deep Long Meeting Tables (2 piece top)

Code	Size (mm)	Group 1 Price (\$)	Group 2 Price (\$)
SP-CNM280	L2800 w1200 h740	775	POA
SP-CNM320	L3200 w1200 h740	897	POA
SP-CNM360	L3600 w1200 h740	947	POA
SP-CNM400	L4000 w1200 h740	987	POA



# VERSA CONFERENCE TABLES

## Circular Conference Tables



### Circular Conference Tables

Code	Size (mm)	Group 1 Price (\$)	Group 2 Price (\$)
CNM100	ø1000 w740	228	242

## Wide Conference Table & Extension



### Wide Conference Table

Code	Type	Size (mm)	Group 1 Price (\$)	Group 2 Price (\$)
CNM143	Starter	w1400 d1640 h740	448	485
CNM144	Extension	w1400 d1640 h740	410	448
CNM163	Starter	w1600 d1640 h740	476	522
CNM164	Extension	w1600 d1640 h740	438	485

Central insert strip must be purchased separately - see below

## Conference Table Inserts (see below for cable cut-out inserts)



### Conference Table Inserts - \* 1 cut out \*\* 2 cut outs

Code	Size (mm)	Group 1 Price (\$)	Group 2 Price (\$)
ZNZ001	w1400 d180 h25	42	51
ZNZ002	w1600 d180 h25	51	56
ZNZ004*	w1400 d180 h25	42	51
ZNZ005*	w1600 d180 h25	51	56
ZNZ007**	w1400 d180 h25	42	51
ZNZ008**	w1600 d180 h25	51	56

## Cable Port Inserts

Cable trays also available - see page 12.



Metal Frame With Lid Open Base

Code CPM3213  
Size (mm) w320 d130 h25  
Price (\$) 27





# VERSA SYSTEM STORAGE

A complete range of system storage to complement the Versa Bench Desking Range.

Cupboards, bookcases, credenzas, locker units. Open fronts, hinged doors, sliding doors, cupboards and other storage exactly designed to fit the desk ends and much, much more.



## Free Standing Bookcases



**Bookcase With 2 Shelves**  
**Code** DNE209  
**Size (mm)** w800 d340 h740  
**Group 1 Price (£)** 128  
**Group 2 Price (£)** 140



**Bookcase With 3 Shelves**  
**Code** DNE309  
**Size (mm)** w800 d340 h1097  
**Group 1 Price (£)** 162  
**Group 2 Price (£)** 179



**Bookcase With 4 Shelves**  
**Code** DNE409  
**Size (mm)** w800 d340 h1449  
**Group 1 Price (£)** 204  
**Group 2 Price (£)** 230



**Bookcase With 5 Shelves**  
**Code** DNE509  
**Size (mm)** w800 d340 h1795  
**Group 1 Price (£)** 255  
**Group 2 Price (£)** 311

## Locking Cupboards



**Cupboard With Lockable Doors 2 Shelves**  
**Code** DNE213  
**Size (mm)** w800 d360 h740  
**Group 1 Price (£)** 238  
**Group 2 Price (£)** 281

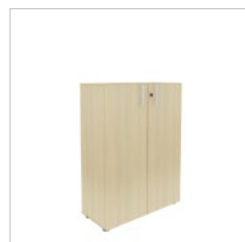

**Cupboard With Lockable Doors 3 Shelves**  
**Code** DNE317  
**Size (mm)** w800 d360 h1097  
**Group 1 Price (£)** 307  
**Group 2 Price (£)** 353



**Cupboard With Lockable Doors 4 Shelves**  
**Code** DNE411  
**Size (mm)** w800 d360 h1449  
**Group 1 Price (£)** 379  
**Group 2 Price (£)** 438



**Cupboard With Lockable Doors 5 Shelves**  
**Code** DNE503  
**Size (mm)** w800 d360 h1795  
**Group 1 Price (£)** 558  
**Group 2 Price (£)** 685

## Executive Credenza with Shelves



**4 Door Cupboard With Shelves**

Code	Size (mm)	Group 1 Price (£)	Group 2 Price (£)
BQL201	w1615 d410 h750	524	592

Touch latch doors (not locking)  
 Contrasting door colour choice available

# VERSA SYSTEM STORAGE

## Desk End Sliding Door Cupboards

Contrasting door colour choice available.



**Desk End Cupboard With Lockable Sliding Doors**  
**Code** DNE216  
**Size (mm)** w1440 d400 h740  
**Group 1 Price (£)** 324  
**Group 2 Price (£)** 379



**Desk End Cupboard With Lockable Sliding Doors**  
**Code** DNE320  
**Size (mm)** w1440 d400 h1090  
**Group 1 Price (£)** 404  
**Group 2 Price (£)** 477



**Desk End Cupboard With Lockable Sliding Doors**  
**Code** DNE210  
**Size (mm)** w1640 d400 h740  
**Group 1 Price (£)** 430  
**Group 2 Price (£)** 528



**Desk End Cupboard With Lockable Sliding Doors**  
**Code** DNE310  
**Size (mm)** w1640 d400 h1090  
**Group 1 Price (£)** 473  
**Group 2 Price (£)** 587

## Desk End Cupboards

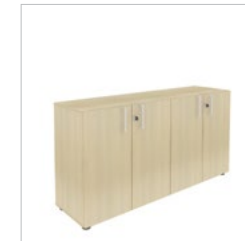

**Desk End Cupboard With Lockable Doors**  
**Code** DNE214  
**Size (mm)** w1440 d400 h740  
**Group 1 Price (£)** 502  
**Group 2 Price (£)** 583



**Desk End Cupboard With Lockable Doors**  
**Code** DNE318  
**Size (mm)** w1440 d400 h1090  
**Group 1 Price (£)** 626  
**Group 2 Price (£)** 732

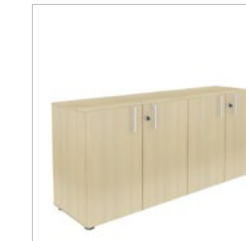

**Desk End Cupboard With Lockable Doors**  
**Code** DNE215  
**Size (mm)** w1640 d400 h740  
**Group 1 Price (£)** 519  
**Group 2 Price (£)** 613



**Desk End Cupboard With Lockable Doors**  
**Code** DNE319  
**Size (mm)** w1640 d400 h1090  
**Group 1 Price (£)** 647  
**Group 2 Price (£)** 775

## Lockers

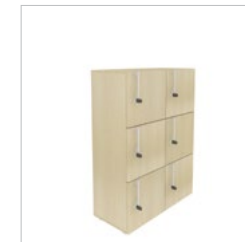

**Locker Unit With 6 Lockable Doors**  
**Code** DNE313  
**Size (mm)** w800 d360 h1097  
**Group 1 Price (£)** 630  
**Group 2 Price (£)** 724



**Locker Unit With 8 Lockable Doors**  
**Code** DNE410  
**Size (mm)** w800 d360 h1449  
**Group 1 Price (£)** 817  
**Group 2 Price (£)** 932

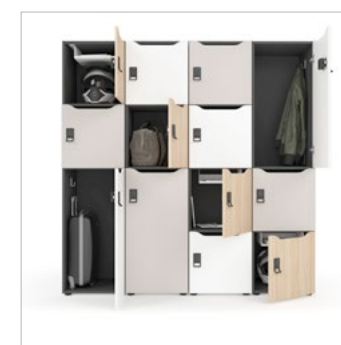

## Select Storage Lockers

See page 68 for our Select Storage Locker range.

## ELECTRA HEIGHT ADJUSTABLE DESKS

One size does not fit all.

There are times when standard height desks just won't do. Chronic back pain? Try sit-stand working with an electric height adjustable desk.

Need an economical sit-stand solution? We've got the answer every time.



Height adjustment button controller

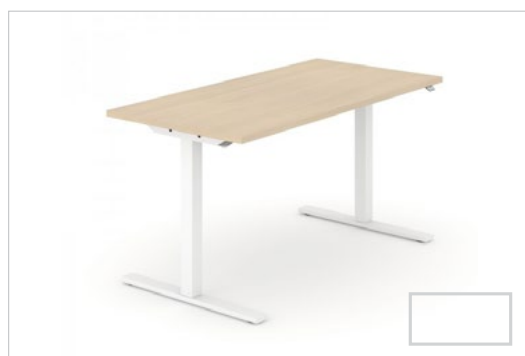

### Straight Back Top

Code	Size (mm)			Price (\$)
DHA14A	w1400	d700	h705-1185	766
DHA16A	w1600	d700	h705-1185	777
DHA14B	w1400	d800	h705-1185	773
DHA16B	w1600	d800	h705-1185	781



### Straight Back Top with Cable Flap\*

Code	Size (mm)			Price (\$)
DHA14C	w1400	d700	h705-1185	791
DHA16C	w1600	d700	h705-1185	799
DHA14D	w1400	d800	h705-1185	795
DHA16D	w1600	d800	h705-1185	806

\*Includes CPM3213 Cable Flap



### Top with scoop

Code	Size (mm)			Price (\$)
DHA14K	w1400	d700	h705-1185	773
DHA16K	w1600	d700	h705-1185	781
DHA14L	w1400	d800	h705-1185	781
DHA16L	w1600	d800	h705-1185	792



### Scoop Back Top

Code	Size (mm)	Price (\$)	
		Group 1	Group 2
DNA125-UH	w1200 d800 h620-850	350	378
DNA145-UH	w1400 d800 h620-850	368	382
DNA165-UH	w1600 d800 h620-850	382	410
DNA185-UH	w1800 d800 h620-850	406	438

Straight Top and Cable Port Cut Out versions also available

## ALTO HEIGHT ADJUSTABLE DESKS

Electric height-adjustable desks that are packed full of features.

ALTO has 3-column legs achieving a desktop height from 610mm up to 1260mm. It can also be equipped with bluetooth connectivity, allowing the user to adjust the desk height with their smart phone.



BA - Height adjustment buttons



MA - Height adjustment button unit with memory function.



LA - Height adjustment button unit with memory function, Bluetooth and LED 'time to sit/stand' reminder.



### Alto Sit/Stand desk frame with adjustable electric legs for 1200-1800mm desktops

Code	Size (mm)			Price (\$)
DZT143-BA	w1170-1770	d700/800	h585-1235	1066
DZT143-LA	w1170-1770	d700/800	h585-1235	1101
DZT143-MA	w1170-1770	d700/800	h585-1235	1101



### Alto Sit/Stand desk frame of 2-desk bench with adjustable electric legs for 1200-1800mm desktop

Code	Size (mm)			Price (\$)
DZT145-BA	w1170-1770	d1368	h585-1235	2117
DZT145-LA	w1170-1770	d1368	h585-1235	2188
DZT145-MA	w1170-1770	d1368	h585-1235	2188



### Desktop

Code	Size (mm)			Price (\$)
DZP120	w1200	d800	h25	46
DZP148	w1400	d800	h25	50
DZP168	w1600	d800	h25	61
DZP188	w1800	d800	h25	64



### Desktop with central cut-out for cable port CPM3213

Code	Size (mm)			Price (\$)
DZP121	w1200	d800	h25	50
DZP146	w1400	d800	h25	53
DZP166	w1600	d800	h25	64
DZP186	w1800	d800	h25	68
CPM3213	w320	d130	h25	27



### Desktop with scoop for cable management

Code	Size (mm)			Price (\$)
DZP124	w1200	d800	h25	50
DZP147	w1400	d800	h25	57
DZP167	w1600	d800	h25	64
DZP187	w1800	d800	h25	71



# SALO HEIGHT ADJUSTABLE BENCH DESKS

Electric height adjustable bench desks for more dynamic and healthy work style.

SALO enables you to easily change your position from sitting to standing.

Regularly changing your body position enhances well-being and concentration. Includes anti-collision feature to avoid items getting trapped.



Electric height adjustable desk with panel legs

Code	Size (mm)	BA Price (€)	MA/LA Price (€)
DOA143	w1400 d1674 h650-1300	1194	1237
DOA163	w1600 d1674 h650-1300	1208	1251
DOA183	w1800 d1674 h650-1300	1230	1272



Electric height adjustable desk with panel legs and Central cable flap

Code	Size (mm)	BA Price (€)	MA/LA Price (€)
DOA144	w1400 d1674 h650-1300	1218	1261
DOA164	w1600 d1674 h650-1300	1229	1272
DOA184	w1800 d1674 h650-1300	1254	1297



Electric height adjustable desk with panel legs and scoop back top

Code	Size (mm)	BA Price (€)	MA/LA Price (€)
DOA145	w1400 d1674 h650-1300	1198	1240
DOA165	w1600 d1674 h650-1300	1208	1251
DOA185	w1800 d1674 h650-1300	1233	1276



Electric height adjustable 2-desk bench

Code	Size (mm)	BA Price (€)	MA/LA Price (€)
DOS14C	w1400 d1674 h650-1300	2309	2395
DOS16C	w1600 d1674 h650-1300	2338	2424
DOS18C	w1800 d1674 h650-1300	2381	2466



Electric height adjustable 2-desk bench with cable flaps

Code	Size (mm)	BA Price (€)	MA/LA Price (€)
DOS14D	w1400 d1674 h650-1300	2358	2443
DOS16D	w1600 d1674 h650-1300	2379	2465
DOS18D	w1600 d1674 h650-1300	2429	2515

# SALO HEIGHT ADJUSTABLE BENCH DESKS



Electric height adjustable 2-desk bench with scoop backs

Code	Size (mm)	BA Price (€)	MA/LA Price (€)
DOS14E	w1400 d1674 h650-1300	2309	2395
DOS16E	w1600 d1674 h650-1300	2338	2424
DOS18E	w1800 d1674 h650-1300	2388	2473



Electric height adjustable 2-desk bench with sliding desktop

Code	Size (mm)	BA Price (€)	MA/LA Price (€)
DOS14F	w1400 d1674 h650-1300	2345	2431
DOS16F	w1600 d1674 h650-1300	2366	2452



Electric height adjustable 2-desk bench with one open metal leg and one panel leg

Code	Size (mm)	BA Price (€)	MA/LA Price (€)
DOS14G	w1400 d1674 h650-1300	2381	2466
DOS16G	w1600 d1674 h650-1300	2409	2495
DOS18G	w1800 d1674 h650-1300	2452	2538



Electric height adjustable 2-desk bench with one open metal leg, one panel leg and cable flaps

Code	Size (mm)	BA Price (€)	MA/LA Price (€)
DOS14H	w1400 d1674 h650-1300	2429	2515
DOS16H	w1600 d1674 h650-1300	2450	2536
DOS18H	w1800 d1674 h650-1300	2500	2586



Electric height adjustable 2-desk bench with one open metal leg and one panel leg. Desktops with scoop backs

Code	Size (mm)	BA Price (€)	MA/LA Price (€)
DOS14J	w1400 d1674 h650-1300	2381	2466
DOS16J	w1600 d1674 h650-1300	2409	2495
DOS18J	w1800 d1674 h650-1300	2459	2545



Electric height adjustable 2-desk bench with one open metal leg, one panel leg and sliding desktops

Code	Size (mm)	BA Price (€)	MA/LA Price (€)
DOS14K	w1400 d1674 h650-1300	2420	2505
DOS16K	w1600 d1674 h650-1300	2441	2527



## SALO HEIGHT ADJUSTABLE BENCH DESKS



Electric Height Adjustable 2-Desk Bench



Electric height adjustable 2-desk bench with panel legs

Code	Size (mm)			BA Price (€)	MA/LA Price (€)
DOS14L	w1400 d1674	h650-1300		2452	2538
DOS16L	w1600 d1674	h650-1300		2481	2566
DOS18L	w1800 d1674	h650-1300		2523	2609



BA - Height adjustment



Electric height adjustable 2-desk bench with panel legs and cable flaps

Code	Size (mm)			BA Price (€)	MA/LA Price (€)
DOS14M	w1400 d1674	h650-1300		2500	2586
DOS16M	w1600 d1674	h650-1300		2522	2607
DOS18M	w1800 d1674	h650-1300		2572	2657



MA - Height adjust + Memory



Electric height adjustable 2-desk bench with panel legs and scoop backs

Code	Size (mm)			BA Price (€)	MA/LA Price (€)
DOS14N	w1400 d1674	h650-1300		2452	2538
DOS16N	w1600 d1674	h650-1300		2481	2566
DOS18N	w1800 d1674	h650-1300		2530	2616



LA - Height adjust + Memory + Bluetooth



Electric height adjustable 2-desk bench with panel legs and sliding desktops

Code	Size (mm)			BA Price (€)	MA/LA Price (€)
DOS14P	w1400 d1674	h650-1300		2495	2580
DOS16P	w1600 d1674	h650-1300		2516	2602

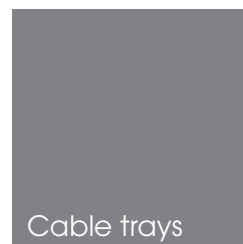

Cable trays



Central cable tray for 1400mm and 1600mm desks. Attaches to the leg frame.

Code	Size (mm)			Price (€)
DOZ001	w1200 d140 h76			68
DOZ002	w1400 d140 h76			78



Cable tray for 1400mm and 1600mm desks. Attaches under the desktop.

Code	Size (mm)			Price (€)
DOZ003	w785 d145 h102			39
DOZ004	w985 d145 h102			43



Set of vertical and horizontal cable covers for cable management along the legs. Attached with magnets.

Code	Size (mm)	Price (€)
ZZZ052	w455 x d53 / w295 x d43 h23	39

## SALO HEIGHT ADJUSTABLE BENCH DESKS



Misc



Fabric-lined metal drawer with lock

Code	Size (mm)			G1 Price (€)	G2 Price (€)
DZZ001	w584 d290 h50			146	153

Drawer can be finished in Camira Lucia (G1 - p122), Velito Presto (G1 - p122) and Camira Synergy (G2 - p125)



Felt-lined metal drawer with lock

Code	Size (mm)			G1 Price (€)	G2 Price (€)
DZZ002	w585 d250 h50			153	160

Drawer can be finished in Camira Lucia (G1 - p122), Velito Presto (G1 - p122) and Camira Synergy (G2 - p125)



Set of desk connecting components - Black or white

Code	Size (mm)	Price (€)
DOZ008	w230 d30 h60	18



Bluetooth adapter for wireless adjustment

Code	Description	Price (€)
ZZZ051	Allows users to control desk height using the "Desk Control App" available for Android and iOS.	61

Bluetooth adapter not required with LA button unit



VCS3 Large Vertical Cable Manager for Sit/Stand Desks - Black only

Code	Size (mm)	Price (€)
VCS3	w68 d36 h1300	45

Silver or White POA



Snap Wrap Cable Manager for Sit/Stand Desks - Silver, White or Black

Code	Size (mm)	Price (€)
VCS080	800mm high	67
VCS150	1500mm high	109

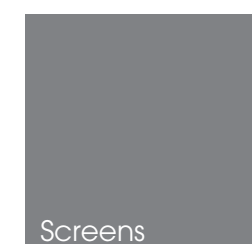

Screens

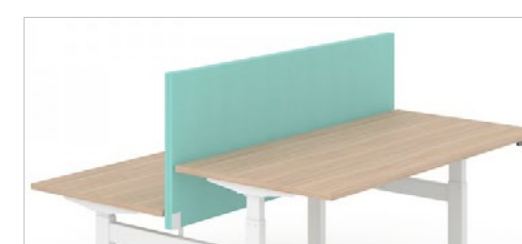

Acoustic screen for 1400mm, 1600mm and 1800mm length desks

Code	Size (mm)	Price (€)
APK142	w1400 d42 h740	271
APK162	w1600 d42 h740	278
APK182	w1800 d42 h740	517

Screens can be finished in Velito Presto fabric (p122) and Camira Synergy (p125)

# OPTO EXTRA CANTILEVER WORKSTATIONS

A superb range of twin post cantilever leg desking.

New White, Silver and Black legs now available



This attractive range includes almost 30 different desk shapes and sizes to fit every situation. Quality 25mm tops and modesty panels in a choice of 7 finishes. Choice of white, silver or black legs and white or silver cable management leg inserts.

## Straight Desk



Code	Size (mm)	Group 1 Price (\$)	Group 2 Price (\$)
DCA081	w800 d800 h720	161	169
DCA101	w1000 d800 h720	165	181
DCA121	w1200 d800 h720	177	193
DCA141	w1400 d800 h720	193	204
DCA161	w1600 d800 h720	200	216
DCA181	w1800 d800 h720	216	240

## Wave 1000



Code	Size (mm)	Group 1 Price (\$)	Group 2 Price (\$)
DCR122	w1200 d800/1000 h720	197	216
DCR142	w1400 d800/1000 h720	204	220
DCR162	w1600 d800/1000 h720	220	244

## Crescent

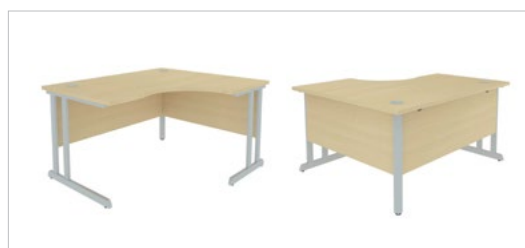

Code	Size (mm)	Group 1 Price (\$)	Group 2 Price (\$)
DCR141	w1400 d800/1200 h720	255	279
DCR161	w1600 d800/1200 h720	275	303
DCR181	w1800 d800/1200 h720	283	310
DCB120*	w1200 d600/1200 h720	252	271

\*Symmetrical Linking Corner



Code	Size (mm)	Group 1 Price (\$)	Group 2 Price (\$)
DCL141	w1400 d800/1200 h720	255	279
DCL161	w1600 d800/1200 h720	275	303
DCL181	w1800 d800/1200 h720	283	310

# OPTO EXTRA CANTILEVER WORKSTATIONS

## Workstation Extensions



Code	Size (mm)	Group 1 Price (\$)	Group 2 Price (\$)
DCD081	w800 d600 h720	134	141
DCD101	w1000 d600 h720	141	153
DCD121	w1200 d600 h720	153	165

## Cable Management Leg Inserts



Code	Size (mm)	Price (\$)
OEVCR	w100 h600	5

Smart triple compartment vertical cable trunk, push fits into leg. Recommended to use with modesty fix cable trays - see page 12. White or Silver.





# OPTO EXTRA PLUS CANTILEVER WORKSTATIONS

A superb range of twin post cantilever leg desking.

**New White Leg Option**



This attractive range includes almost 30 different desk shapes and sizes to fit every situation. Quality 25mm tops and modesty panels in a choice of 7 finishes. Choice of silver or white legs. Includes cable management leg inserts.



### Straight Desk

Code	Size (mm)			Group 1 Price (\$)	Group 2 Price (\$)
DCA081+	w800	d800	h720	172	180
DCA101+	w1000	d800	h720	176	192
DCA121+	w1200	d800	h720	188	203
DCA141+	w1400	d800	h720	203	215
DCA161+	w1600	d800	h720	211	227
DCA181+	w1800	d800	h720	227	251



### Right Hand

Code	Size (mm)			Group 1 Price (\$)	Group 2 Price (\$)
DCR122+	w1200	d800/1000	h720	207	227
DCR142+	w1400	d800/1000	h720	215	231
DCR162+	w1600	d800/1000	h720	231	255



### Left Hand

Code	Size (mm)			Group 1 Price (\$)	Group 2 Price (\$)
DCL122+	w1200	d800/1000	h720	207	227
DCL142+	w1400	d800/1000	h720	215	231
DCL162+	w1600	d800/1000	h720	231	255



### Right Hand

Code	Size (mm)			Group 1 Price (\$)	Group 2 Price (\$)
DCR141+	w1400	d800/1200	h720	266	290
DCR161+	w1600	d800/1200	h720	286	313
DCR181+	w1800	d800/1200	h720	294	321
DCB120+*	w1200	d600/1200	h720	262	282

\*Symmetrical Linking Corner



### Left Hand

Code	Size (mm)			Group 1 Price (\$)	Group 2 Price (\$)
DCL141+	w1400	d800/1200	h720	266	290
DCL161+	w1600	d800/1200	h720	286	313
DCL181+	w1800	d800/1200	h720	294	321

# OPTO EXTRA PLUS CANTILEVER WORKSTATIONS

Workstation Extensions

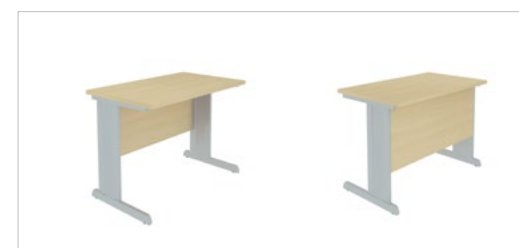

### Workstation Extensions

Code	Size (mm)			Group 1 Price (\$)	Group 2 Price (\$)
DCD081+	w800	d600	h720	144	152
DCD101+	w1000	d600	h720	152	164
DCD121+	w1200	d600	h720	164	176





## OPTO PANEL LEG DESKS

A versatile range of well priced, traditionally styled office furniture.

25mm work tops with 2mm edging, solid 25mm leg and modesty panels. Seven finishes to choose from and a complete range of matching pedestals, storage and meeting tables (see later pages).



### Straight Desk

Code	Size (mm)			Group 1 Price (\$)	Group 2 Price (\$)
DDA081	w800	d800	h720	128	140
DDA101	w1000	d800	h720	131	153
DDA121	w1200	d800	h720	142	164
DDA141	w1400	d800	h720	157	175
DDA161	w1600	d800	h720	164	186
DDA181	w1800	d800	h720	179	208



### Right Hand

Code	Size (mm)			Group 1 Price (\$)	Group 2 Price (\$)
DDR122	w1200	d800/1000	h720	160	186
DDR142	w1400	d800/1000	h720	168	189
DDR162	w1600	d800/1000	h720	182	211

### Left Hand

Code	Size (mm)			Group 1 Price (\$)	Group 2 Price (\$)
DDL122	w1200	d800/1000	h720	160	186
DDL142	w1400	d800/1000	h720	168	189
DDL162	w1600	d800/1000	h720	182	211



### Right Hand

Code	Size (mm)			Group 1 Price (\$)	Group 2 Price (\$)
DDR141	w1400	d800/1200	h720	208	240
DDR161	w1600	d800/1200	h720	226	262
DDR181	w1800	d800/1200	h720	233	270

### Left Hand

Code	Size (mm)			Group 1 Price (\$)	Group 2 Price (\$)
DDL141	w1400	d800/1200	h720	208	240
DDL161	w1600	d800/1200	h720	226	262
DDL181	w1800	d800/1200	h720	233	270



## OPTO PANEL LEG DESKS



### Symmetrical Linking Corner

Code	Size (mm)			Group 1 Price (\$)	Group 2 Price (\$)
DDB120	w1200	d600/1200	h720	189	219



### Workstation Extensions

Code	Leg type	Size (mm)			Group 1 Price (\$)	Group 2 Price (\$)
DDD082	Full Depth	w800	d600	h720	95	109
DDD102	Full Depth	w1000	d600	h720	102	120
DDD122	Full Depth	w1200	d600	h720	113	131
DDD081	Cut-back	w800	d600	h720	95	113
DDD101	Cut-back	w1000	d600	h720	102	124
DDD121	Cut-back	w1200	d600	h720	113	135



# MFC PEDESTALS

Matching pedestals and desk height storage.

A huge choice to suit every requirement and situation – don't forget the pen trays and cushions!

Also see Versa Pedestals on page 9 and Steel Pedestals on page 110.



## Contract Fixed Pedestals



1 Standard Drawer  
1 Filing Drawer

**Code** PSP525  
**Size (mm)** w415 d500 h446  
**Group 1 Price (£)** 141  
**Group 2 Price (£)** 161

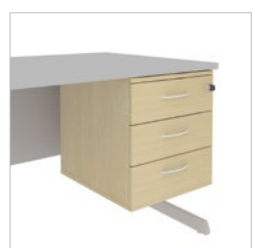

3 Standard Drawers

**Code** PSP532  
**Size (mm)** w415 d500 h446  
**Group 1 Price (£)** 130  
**Group 2 Price (£)** 157

## Heavy Duty Mobile Pedestals

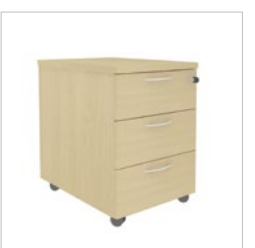

3 Standard Drawers

**Code** PUR636  
**Size (mm)** w430 d600 h600  
**Group 1 Price (£)** 303  
**Group 2 Price (£)** 346

## Contract Mobile Pedestals

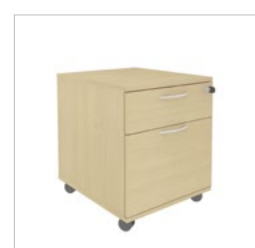

1 Standard Drawer  
1 Filing Drawer

**Code** PSR525  
**Size (mm)** w415 d500 h510  
**Group 1 Price (£)** 157  
**Group 2 Price (£)** 185

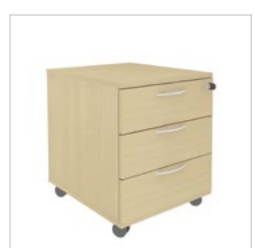

3 Standard Drawers

**Code** PSR532  
**Size (mm)** w415 d500 h510  
**Group 1 Price (£)** 153  
**Group 2 Price (£)** 177



2 Standard Drawers  
1 Filing Drawer

**Code** PSR535  
**Size (mm)** w415 d500 h638  
**Group 1 Price (£)** 177  
**Group 2 Price (£)** 200

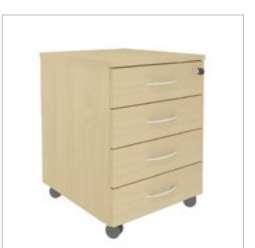

4 Standard Drawers

**Code** PSR541  
**Size (mm)** w415 d500 h638  
**Group 1 Price (£)** 165  
**Group 2 Price (£)** 189

## Contract Desk Height Pedestals

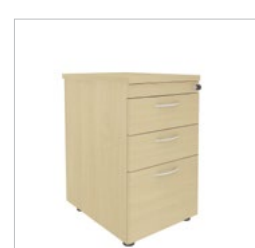

2 Standard Drawers  
1 Filing Drawer  
(full depth file drawer)

**Code** PSS637  
**Size (mm)** w415 d600 h720  
**Group 1 Price (£)** 193  
**Group 2 Price (£)** 228

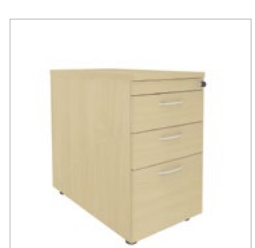

2 Standard Drawers  
1 Filing Drawer  
(extra deep file drawer)

**Code** PSS837  
**Size (mm)** w415 d800 h720  
**Group 1 Price (£)** 212  
**Group 2 Price (£)** 244



4 Standard Drawers

**Code** PSS642  
**Size (mm)** w415 d600 h720  
**Group 1 Price (£)** 189  
**Group 2 Price (£)** 216

# MFC PEDESTALS & DESK HEIGHT STORAGE

## Heavy Duty Desk Height Pedestals



2 Standard Drawers  
1 Filing Drawer

**Code** PUS635  
**Size (mm)** w430 d600 h722  
**Group 1 Price (£)** 275  
**Group 2 Price (£)** 318

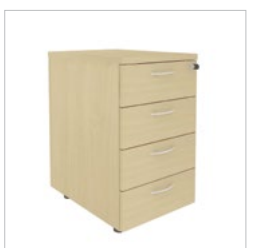

4 Standard Drawers

**Code** PUS642  
**Size (mm)** w430 d600 h722  
**Group 1 Price (£)** 287  
**Group 2 Price (£)** 334

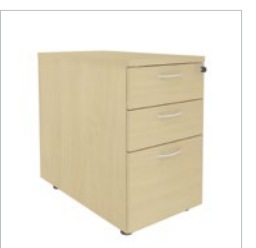

2 Standard Drawers  
1 Filing Drawer

**Code** PUS835  
**Size (mm)** w430 d800 h722  
**Group 1 Price (£)** 310  
**Group 2 Price (£)** 373

## Filing Cabinets



2 Drawer  
Desk height

**Code** PEX627  
**Size (mm)** w500 d600 h720  
**Group 1 Price (£)** 228  
**Group 2 Price (£)** 263

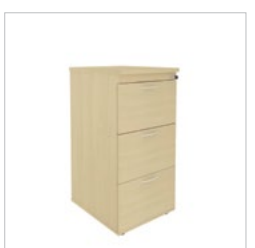

3 Drawer

**Code** PEX637  
**Size (mm)** w500 d600 h1020  
**Group 1 Price (£)** 303  
**Group 2 Price (£)** 350



4 Drawer

**Code** PEX647  
**Size (mm)** w500 d600 h1320  
**Group 1 Price (£)** 385  
**Group 2 Price (£)** 444

## Cushion For Pedestal Tops



Pedestal cushion

**Code** DNZ002  
**Size (mm)** w590 d420  
**Group 1 Price (£)** 95  
**Group 2 Price (£)** 119

## Pen Trays



For PSR and PSS pedestals

**Code** ZZZ004  
**Size (mm)** w335 d235  
**Price (£)** 12



For PUR and PUS pedestals

**Code** ZZZ006  
**Size (mm)** w368 d250  
**Price (£)** 16

## Desk Height Storage



Shallow open front unit  
1 shelf

**Code** PXA420  
**Size (mm)** w800 d400 h720  
**Group 1 Price (£)** 95  
**Group 2 Price (£)** 107



Open front unit  
1 shelf

**Code** PXA620  
**Size (mm)** w800 d600 h720  
**Group 1 Price (£)** 119  
**Group 2 Price (£)** 139

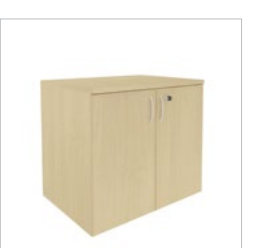

Cupboard  
Lockable doors  
1 shelf

**Code** PXD620  
**Size (mm)** w800 d600 h720  
**Group 1 Price (£)** 194  
**Group 2 Price (£)** 218

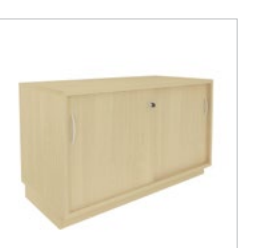

Cupboard  
Lockable sliding doors  
Internal shelf

**Code** PXL620  
**Size (mm)** w1200 d600 h720  
**Group 1 Price (£)** 281  
**Group 2 Price (£)** 329



## MEDIA WALL UNITS

### Multimedia integration.

MEDIA is a smart solution to integrate today's technology into your meeting areas.

A simple way to mount a large screen and manage the power and cabling, especially in an open plan office without minimal wall space. Includes brackets for joining to meeting tables.



**Media wall with VESA mount and power socket (1 extension, 4 pass through holes for cables)**

Code	Size (mm)	Group 1 Price (€)	Group 2 Price (€)
CMZ120	w1200 d132 h1550	561	606

CMZ120 and CMZ121 are compatible with the following tables:

CGM200, CGM201, CGM280, CGM320, CGM202, CGM203, CGM281, CGM321 (see page 43)

DZM202 and DZM242 (see page 49)

CNM120 up to CNM400 (see page 24)



**Media wall with VESA mount and cut-out with white plastic cable port**

Code	Size (mm)	Group 1 Price (€)	Group 2 Price (€)
CMZ121	w1200 d132 h1550	423	463



**Media wall with VESA mount and power socket (1 extension, 4 cable holes)**

Code	Size (mm)	Group 1 Price (€)	Group 2 Price (€)
CMZ122	w1200 d132 h1860	624	677

Compatible with the following tables: CGM180, CNM165 and CNM185 (see page 50).

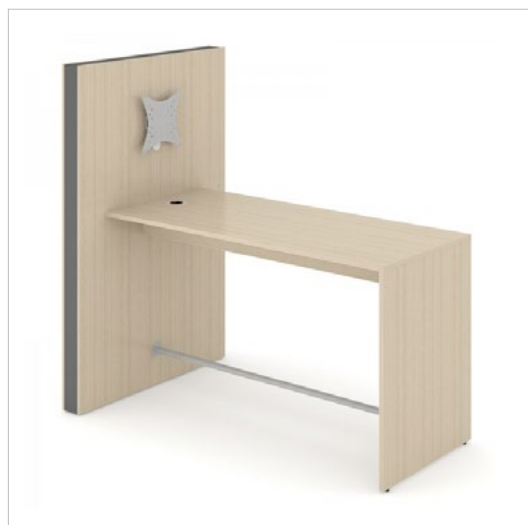

**Media wall (1200x132 h1860) with VESA mount high table (1800x800 h1050) and power socket (1 extension, 4 cable holes) on the tabletop**

Code	Size (mm)	Group 1 Price (€)	Group 2 Price (€)
CMM122	w1200 d132 h1860	825	913

Table size: 1800mm x 800mm

## RATIO MEETING TABLES

### Highly versatile meeting tables.

The Ratio system offers functional meeting tables for teams of eight, ten and twelve people.

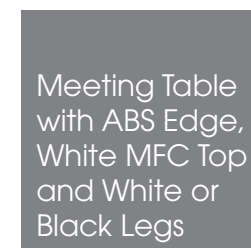

Meeting table (8 seats)

Code	Size (mm)	Price (€)
CGM200	w2000 d1200 h740	810



Meeting table (8 seats) with two power sockets and a metal cable tray

Code	Size (mm)	Price (€)
CGM201	w2000 d1200 h740	1143



Meeting table (10 seats) with two power sockets and a metal cable tray

Code	Size (mm)	Price (€)
CGM280	w2800 d1200 h740	1652



Meeting table (12 seats) with two power sockets and a metal cable tray

Code	Size (mm)	Price (€)
CGM320	w3200 d1200 h740	1716

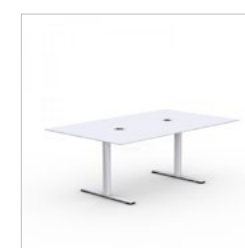

Meeting table (8 seats) with two power sockets and a metal cable tray

Code	Size (mm)	Price (€)
CGM203	w2000 d1200 h740	1463



Meeting table (10 seats) with two power sockets and a metal cable tray

Code	Size (mm)	Price (€)
CGM281	w2800 d1200 h740	2101



Meeting table (12 seats) with two power sockets and a metal cable tray

Code	Size (mm)	Price (€)
CGM321	w3200 d1200 h740	2221



# OPTO MEETING & TRAINING TABLES

Meeting, greeting, training. A flexible modular system of all shapes and sizes.

Whether it's a meeting point on the end of a desk or a complete flexible training room requirement we've got what you need.

Individual tables for exams or training - no problem; a conference for 20 - just push the tables together, add some half round ends for an instant result.



**Flip-Top Tables - 700mm Deep**



**Rectangular** - Black, silver or white flip-top base, with castors

Code	Size (mm)	Group 1 Price (€)	Group 2 Price (€)
DFT122	w1200 d700 h720	352	370
DFT142	w1400 d700 h720	409	423
DFT162	w1600 d700 h720	376	394
DFT182	w1800 d700 h720	390	408

Anthracite also available - minimum order quantity may apply

For quadrant link please use pole leg DPL973.

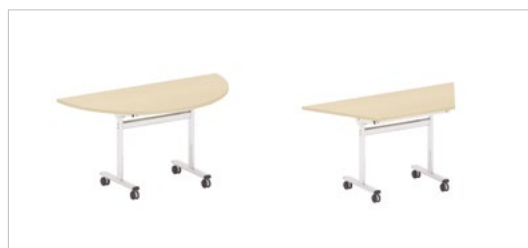

**Shaped Meeting Ends** - Black, silver or white flip-top base with castors

Code	Size (mm)	Group 1 Price (€)	Group 2 Price (€)
DFT183	w1400 d700 h720	401	416
DFT185	w1400 d606* h720	366	384

\* Trapezoidal table is 606mm deep with 700mm sides/ends  
Anthracite also available - minimum order quantity may apply

**Flip-Top Tables - 800mm Deep**



**Rectangular** - Black, silver or white flip-top base, with castors

Code	Size (mm)	Group 1 Price (€)	Group 2 Price (€)
DFT121	w1200 d800 h720	370	388
DFT141	w1400 d800 h720	384	402
DFT161	w1600 d800 h720	394	412
DFT181	w1800 d800 h720	412	429

Anthracite also available - minimum order quantity may apply

For quadrant link please use pole leg DPL903.



**Shaped Meeting Ends** - Black, silver or white flip-top base with castors

Code	Size (mm)	Group 1 Price (€)	Group 2 Price (€)
DFT180	w1600 d800 h720	366	373
DFT184	w1600 d693* h720	395	413

\* Trapezoidal table is 693mm deep with 800mm sides/ends  
Anthracite also available - minimum order quantity may apply

**Folding Leg Tables - 700mm Deep**



**Rectangular** - Silver folding legs

Code	Size (mm)	Group 1 Price (€)	Group 2 Price (€)
DZA122	w1200 d700 h720	235	254
DZA142	w1400 d700 h720	294	309
DZA162	w1600 d700 h720	254	274
DZA182	w1800 d700 h720	266	286

# OPTO MEETING & TRAINING TABLES

**Folding Leg Tables - 700mm Deep**



**Shaped Meeting Ends** - Silver folding legs

Code	Size (mm)	Group 1 Price (€)	Group 2 Price (€)
DZA183	w1400 d700 h720	294	309
DZA185	w1400 d606* h720	254	274

\* Trapezoidal table is 606mm deep with 700mm sides/ends

**Folding Leg Tables - 800mm Deep**



**Rectangular** - Silver folding legs

Code	Size (mm)	Group 1 Price (€)	Group 2 Price (€)
DZA121	w1200 d800 h720	243	262
DZA141	w1400 d800 h720	254	274
DZA161	w1600 d800 h720	262	282
DZA181	w1800 d800 h720	278	298

For quadrant link please use pole leg DPL903.

Chrome legs also available POA.



**Shaped Meeting Ends** - Silver folding legs

Code	Size (mm)	Group 1 Price (€)	Group 2 Price (€)
DZA180	w1600 d800 h720	239	247
DZA184	w1600 d693* h720	270	290

\* Trapezoidal table is 693mm deep with 800mm sides/ends



## OPTO MEETING & TRAINING TABLES

### Detachable Pole Leg Tables - 700mm Deep



Rectangular - ø60mm silver detachable pole legs

Code	Size (mm)	Group 1 Price (\$)	Group 2 Price (\$)
DPL122	w1200 d700 h720	142	162
DPL142	w1400 d700 h720	201	217
DPL162	w1600 d700 h720	162	182
DPL182	w1800 d700 h720	174	193

No underframe.

Chrome legs also available POA.



Shaped Meeting Ends - ø60mm silver detachable pole legs

Code	Size (mm)	Group 1 Price (\$)	Group 2 Price (\$)
DPL183	w1400 d700 h720	201	217
DPL973	w700 d700 h720	123	142
DPL185	w1400 d606* h720	162	182

\* Trapezoidal table is 606mm deep with 700mm sides/ends

### Detachable Pole Leg Tables - 800mm Deep



Rectangular - ø60mm silver detachable pole legs

Code	Size (mm)	Group 1 Price (\$)	Group 2 Price (\$)
DPL081	w800 d800 h720	130	150
DPL121	w1200 d800 h720	150	170
DPL141	w1400 d800 h720	162	182
DPL161	w1600 d800 h720	170	189
DPL181	w1800 d800 h720	185	205

No underframe.

Chrome legs also available POA.



Shaped Meeting Ends - ø60mm silver detachable pole legs

Code	Size (mm)	Group 1 Price (\$)	Group 2 Price (\$)
DPL180	w1600 d800 h720	146	154
DPL903	w800 d800 h720	201	205
DPL184	w1600 d693* h720	178	197

\* Trapezoidal table is 693mm deep with 800mm sides/ends

### Semi-circular Meeting Ends



4 Leg, 180° ø50mm metal fixed pole legs

Code	Size (mm)	Group 1 Price (\$)	Group 2 Price (\$)
DZC180	ø800 d1600 h720	134	141



2 Leg, 180° ø50mm metal fixed pole legs

Code	Size (mm)	Group 1 Price (\$)	Group 2 Price (\$)
DZC181	ø800 d1600 h720	149	157

## OPTO MEETING & TRAINING TABLES

### Quadrant Links



2 Leg, 90° ø50mm metal fixed pole legs

Code	Size (mm)	Group 1 Price (\$)	Group 2 Price (\$)
DZC900	ø800 d800 h720	126	130



1 Leg, 90° ø50mm metal fixed pole leg

Code	Size (mm)	Group 1 Price (\$)	Group 2 Price (\$)
DZC901	ø800 d800 h720	122	126

### Meeting Ends



Half round, Linking ø50mm metal fixed pole leg

Code	Size (mm)	Group 1 Price (\$)	Group 2 Price (\$)
DZC183	w800 d400 h720	55	59



Bubble end, Linking ø50mm metal fixed pole legs. For 800mm cantilever end

Code	Size (mm)	Group 1 Price (\$)	Group 2 Price (\$)
DZC360	w1100 d1000 h720	161	169



Bubble end, Linking ø50mm metal fixed pole legs. For 800mm panel end

Code	Size (mm)	Group 1 Price (\$)	Group 2 Price (\$)
DDC360	w1100 d1000 h720	109	117



270° Meeting point For 600 end, ø50mm metal fixed pole legs

Code	Size (mm)	Group 1 Price (\$)	Group 2 Price (\$)
DZC271	w1200 d1200 h720	149	157

### Table Connectors



Fittings for desktop connection, 1 set of 2 pcs

Code	Price (\$)
TC1-2	17

Swivel table connector, 1 set of 2 pcs

Code	Price (\$)
TC2-2	43

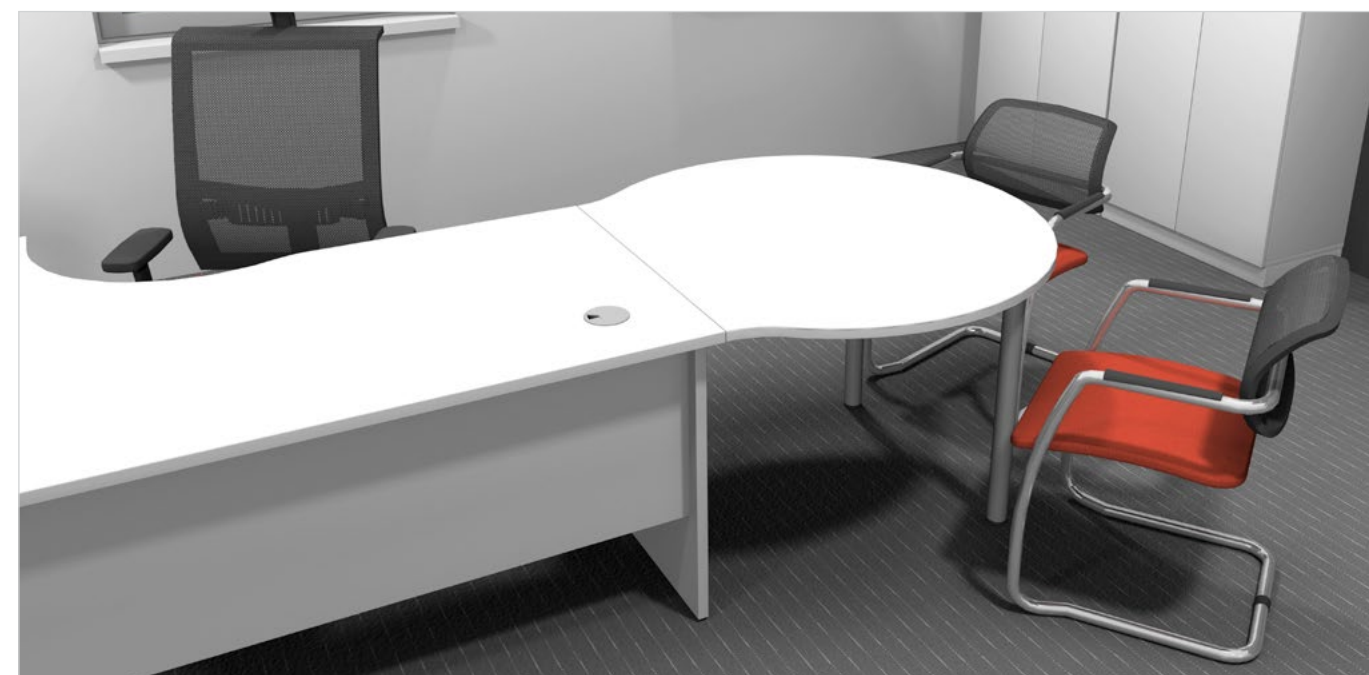



# OPTO MEETING & CONFERENCE TABLES

Smart and businesslike, Opto Conference tables are a touch of class on a modest budget.

All come with 25mm tops, 2mm lippings, a sturdy timber panel base or pole legs with a metal under frame. For an added touch of class why not have a pedestal column base?



## Round Meeting Tables



Code		Size (mm)		Group 1 Price (€)	Group 2 Price (€)
CZM100	ø1000	h720		126	134
CZM120	ø1200	h720		153	165



Code		Size (mm)		Group 1 Price (€)	Group 2 Price (€)
CZM101	ø1000	h720		138	157
CZM121	ø1200	h720		177	200



Disqus Metal Pedestal Base (Bases available in Black, Silver or White)						
Code		Size (mm)		Base (mm)	Group 1 Price (€)	Group 2 Price (€)
COM080	ø800	h740		ø500	341	345
COM090	ø900	h740		ø700	428	436
COM100	ø1000	h740		ø700	440	444
COM120	ø1200	h740		ø700	464	476
COM141	ø1400	h740		ø700	476	488



## D-Ended Meeting Tables



Code		Size (mm)		Group 1 Price (€)	Group 2 Price (€)
CZM201	w2000	d1000	h720	224	255
CZM241	w2400	d1000	h720	255	291

Code		Size (mm)		Group 1 Price (€)	Group 2 Price (€)
CZM200	w2000	d1000	h720	255	287
CZM240	w2400	d1000	h720	295	326

## Square-Ended Meeting Tables



Panel leg



Pole leg



T-leg. Includes central cable port. For cable trays see page 12



T-leg. Includes central cable port. For cable trays see page 12

Code		Size (mm)		Group 1 Price (€)	Group 2 Price (€)
CZM203	w2000	d1000	h720	228	259

Code		Size (mm)		Group 1 Price (€)	Group 2 Price (€)
CZM202	w2000	d1000	h720	259	291

Code		Size (mm)		Price (€)
DZM202	w2000	d1200	h740	322

Code		Size (mm)		Price (€)
DZM242	w2400	d1200	h740	358

## Barrel Top Meeting Tables



Panel leg



Pole leg

Code		Size (mm)		Group 1 Price (€)	Group 2 Price (€)
CZM243	w2400	d1000/1200	h720	279	326

Code		Size (mm)		Group 1 Price (€)	Group 2 Price (€)
CZM242	w2400	d1000/1200	h720	318	358



## Coffee Tables



Square MFC



Rectangular MFC



Round MFC



Round MFC

Code		Size (mm)		Group 1 Price (€)	Group 2 Price (€)
ZZN603	w600	d600	h400	86	98

Code		Size (mm)		Group 1 Price (€)	Group 2 Price (€)
ZZN100	w1000	d600	h400	110	122

Code		Size (mm)		Group 1 Price (€)	Group 2 Price (€)
ZZN651	ø650	h400		83	90

Code		Size (mm)		Group 1 Price (€)	Group 2 Price (€)
CNN080	ø850	h440		349	364

# OPTO MEETING & CONFERENCE TABLES



## BREAKOUT TABLES

A smart, well thought out range of high tables for canteens and breakout areas.

Available in a variety of heights, styles and sizes to suit every situation.

See also Coffee Tables on previous page.



### High 'O' Leg Breakout Table

Code	Size (mm)	Price (€)
CGM180	w1800 d700 h1030	429

Top available in white only  
Legs available in black or white

### High Panel End Breakout Table

Code	Size (mm)	Price (€)
CTM160	w1600 d700 h1050	248
CTM180	w1800 d700 h1050	261

Available in White, Beech, Whitened Oak and Amber Oak MFC

### High 'H' Leg Breakout Table

Code	Size (mm)	Group 1 Price (€)	Group 2 Price (€)
CNM165	w1600 d700 h1050	286	311
CNM180	w1800 d700 h1050	332	358



## DISQUS CONFERENCE TABLES

The most versatile range of conference tables on the market.

Modular tops and bases make for endless size and shape possibilities, infinitely expandable and ideal for larger arrangements. 38mm thick real wood veneer tops also available - POA. See page 48 for circular version.

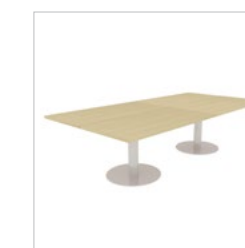

Circular tables also available - see page 48.

6-8 Person Table

8-10 Person Table

12-14 Person Table

10-12 Person Table

Code	COM200
Size (mm)	w2000 d1000 h740
Group 1 Price (€)	860
Group 2 Price (€)	876

Code	COM280
Size (mm)	w2800 d1400 h740
Group 1 Price (€)	1039
Group 2 Price (€)	1070

Code	COM420
Size (mm)	w4200 d1400 h740
Group 1 Price (€)	1558
Group 2 Price (€)	1606

Code	COM282
Size (mm)	w2800 d1400 h740
Group 1 Price (€)	1039
Group 2 Price (€)	1070



Standard colours Silver and White. Anthracite and black also available to special order, minimum quantities may apply.

Disqus table base for up to ø1000mm top

Disqus table base for up to ø850mm top

Disqus table base for up to ø1000mm top

Disqus table base for up to ø1400mm top

Code	DQB050S
Head ø (mm)	600
Pole ø (mm)	76
Base ø (mm)	500
Height (mm)	415
Price (€)	295

Code	DQB050
Head ø (mm)	710
Pole ø (mm)	76
Base ø (mm)	500
Height (mm)	715
Price (€)	299

Code	DQB100
Head ø (mm)	710
Pole ø (mm)	115
Base ø (mm)	700
Height (mm)	715
Price (€)	374

Code	DQB150
Head ø (mm)	910
Pole ø (mm)	115
Base ø (mm)	700
Height (mm)	715
Price (€)	377



Joint strengthening plate 1 set of 2 pcs

Rectangular

Semi-circular

Code	ZIZ001
Price (€)	8

Code	G2A348
Size (mm)	w1400 d700
Group 1 Price (€)	63
Group 2 Price (€)	71

Code	G2A349
Size (mm)	w1400 d700
Group 1 Price (€)	63
Group 2 Price (€)	71

# COMBO STORAGE

A choice of over 60 cupboard and bookcase combinations.

All storage units have 19mm carcasses, 25mm tops to complement desking and finished backs for use as room dividers. Combo cupboards include shelves and locks. All units are supplied without a base, this must be chosen from the options on page 58. Alternative handles, metal feet and castor options are also available, see pages 58-59.



## Wall Mounted Shelves

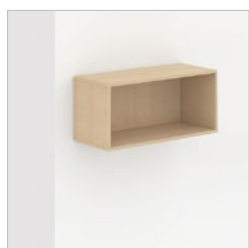

Wall mounted shelf

**Code** X1N081  
**Size (mm)** w800 d336 h370  
**Group 1 Price (£)** 55  
**Group 2 Price (£)** 63

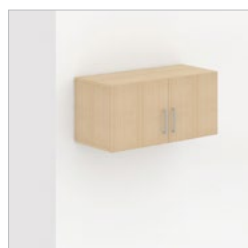

Wall mounted shelf with doors

**Code** X1C081  
**Size (mm)** w800 d356 h370  
**Group 1 Price (£)** 107  
**Group 2 Price (£)** 127

## Bookcases

**Please note:**

All bookcases come without a base. Please see page 58 for a range of available bases.



Bookcase 2 levels - 800mm

**Code** X2N081  
**Size (mm)** w800 d425 h754  
**Group 1 Price (£)** 111  
**Group 2 Price (£)** 123

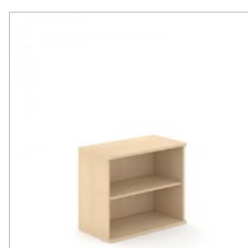

Bookcase 2 levels - 1000mm

**Code** X2N101  
**Size (mm)** w1000 d425 h754  
**Group 1 Price (£)** 123  
**Group 2 Price (£)** 143

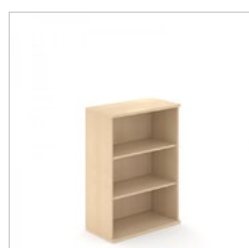

Bookcase 3 levels - 800mm

**Code** X3N081  
**Size (mm)** w800 d425 h1120  
**Group 1 Price (£)** 154  
**Group 2 Price (£)** 174

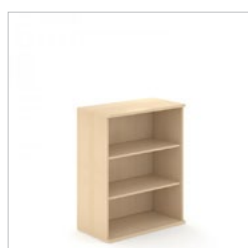

Bookcase 3 levels - 1000mm

**Code** X3N101  
**Size (mm)** w1000 d425 h1120  
**Group 1 Price (£)** 182  
**Group 2 Price (£)** 222



Bookcase 4 levels - 800mm

**Code** X4N081  
**Size (mm)** w800 d425 h1508  
**Group 1 Price (£)** 190  
**Group 2 Price (£)** 218

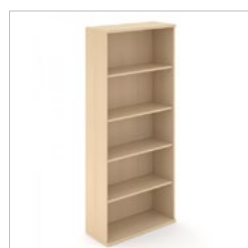

Bookcase 5 levels - 600mm

**Code** X5N061  
**Size (mm)** w600 d425 h1874  
**Group 1 Price (£)** 174  
**Group 2 Price (£)** 206

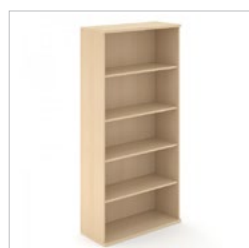

Bookcase 5 levels - 800mm

**Code** X5N081  
**Size (mm)** w800 d425 h1874  
**Group 1 Price (£)** 214  
**Group 2 Price (£)** 246



Bookcase 5 levels - 1000mm

**Code** X5N101  
**Size (mm)** w1000 d425 h1874  
**Group 1 Price (£)** 253  
**Group 2 Price (£)** 297

# COMBO STORAGE

## Bookcases

**Please note:**

All bookcases come without a base. Please see page 58 for a range of available bases.



Bookcase 6 levels - 600mm

**Code** X6N061  
**Size (mm)** w600 d425 h2240  
**Group 1 Price (£)** 230  
**Group 2 Price (£)** 261



Bookcase 6 levels - 800mm

**Code** X6N081  
**Size (mm)** w800 d425 h2240  
**Group 1 Price (£)** 246  
**Group 2 Price (£)** 281

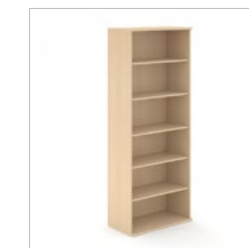

Bookcase 6 levels - 1000mm

**Code** X6N101  
**Size (mm)** w1000 d425 h2240  
**Group 1 Price (£)** 309  
**Group 2 Price (£)** 356

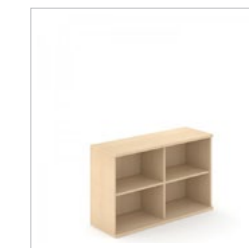

Shelf unit 2 levels 1 divider - 1200mm

**Code** X2N121  
**Size (mm)** w1200 d425 h754  
**Group 1 Price (£)** 162  
**Group 2 Price (£)** 190



Bookcase 5 levels 1 divider - 1200mm

**Code** X5N121  
**Size (mm)** w1200 d425 h1874  
**Group 1 Price (£)** 309  
**Group 2 Price (£)** 364

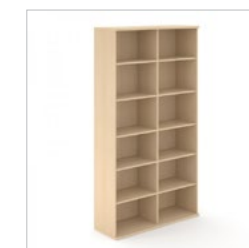

Bookcase 6 levels 1 divider - 1200mm

**Code** X6N121  
**Size (mm)** w1200 d425 h2240  
**Group 1 Price (£)** 364  
**Group 2 Price (£)** 432

## Cupboards

**Please note:**

All cupboards come without a base. Please see page 58 for a range of available bases.



Cupboard with low hinged door (L/H) 5 levels

**Code** X5H061  
**Size (mm)** w600 d425 h1874  
**Group 1 Price (£)** 246  
**Group 2 Price (£)** 289



Cupboard with low hinged door (R/H) 5 levels

**Code** X5H062  
**Size (mm)** w600 d425 h1874  
**Group 1 Price (£)** 246  
**Group 2 Price (£)** 289

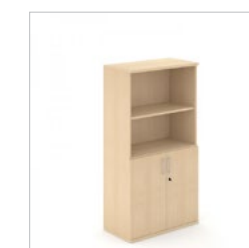

Cupboard with low double doors 4 levels

**Code** X4H081  
**Size (mm)** w800 d425 h1508  
**Group 1 Price (£)** 289  
**Group 2 Price (£)** 329

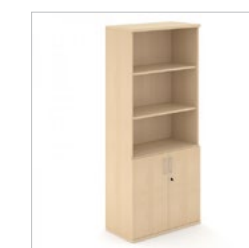

Cupboard with low double doors 5 levels

**Code** X5H081  
**Size (mm)** w800 d425 h1874  
**Group 1 Price (£)** 301  
**Group 2 Price (£)** 348

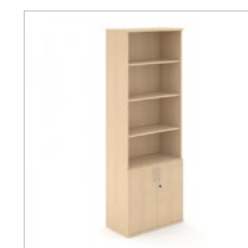

Cupboard with low double doors 6 levels

**Code** X6H081  
**Size (mm)** w800 d425 h2240  
**Group 1 Price (£)** 333  
**Group 2 Price (£)** 384

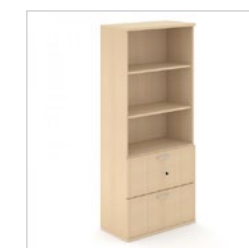

Cupboard with 2 slidefil drawers 5 levels

**Code** X5F081  
**Size (mm)** w800 d425 h1874  
**Group 1 Price (£)** 737  
**Group 2 Price (£)** 764

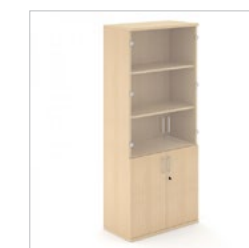

Cupboard with glass upper doors and low double doors - 5 levels

**Code** X5G081  
**Size (mm)** w800 d425 h1874  
**Group 1 Price (£)** 570  
**Group 2 Price (£)** 618



## COMBO STORAGE

## Tambour Door Cupboards



Cupboard with tambour doors  
2 levels

**Code** X2T101  
**Size (mm)** w1000 d425 h754  
**Group 1 Price (€)** 372  
**Group 2 Price (€)** 396



Cupboard with tambour doors  
3 levels

**Code** X3T101  
**Size (mm)** w1000 d425 h1120  
**Group 1 Price (€)** 511  
**Group 2 Price (€)** 554



## Side Filer

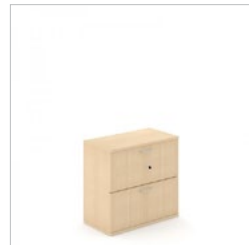

Side filer with 2 file drawers for both A4 and foolscap files - 800mm

**Code** X2F081  
**Size (mm)** w800 d425 h754  
**Group 1 Price (€)** 626  
**Group 2 Price (€)** 701

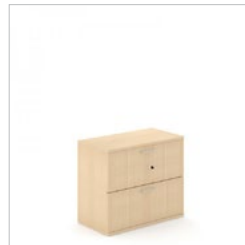

Side filer with 2 file drawers for both A4 and foolscap files - 1000mm

**Code** X2F101  
**Size (mm)** w1000 d425 h754  
**Group 1 Price (€)** 693  
**Group 2 Price (€)** 776

## Sliding Door Cupboards

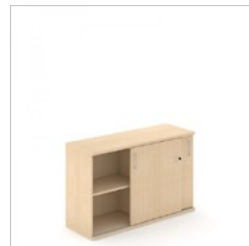

Cupboard with Sliding lockable doors  
2 levels - 1000mm

**Code** X2S101  
**Size (mm)** w1000 d425 h754  
**Group 1 Price (€)** 253  
**Group 2 Price (€)** 297

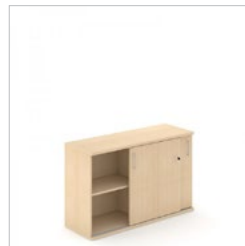

Cupboard with Sliding lockable doors  
2 levels - 1200mm

**Code** X2S121  
**Size (mm)** w1200 d425 h754  
**Group 1 Price (€)** 265  
**Group 2 Price (€)** 305

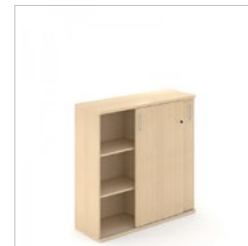

Cupboard with Sliding lockable doors  
3 levels - 1000mm

**Code** X3N101  
**Size (mm)** w1000 d425 h1120  
**Group 1 Price (€)** 123  
**Group 2 Price (€)** 143

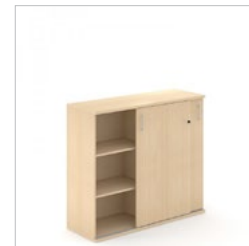

Cupboard with Sliding lockable doors  
3 levels - 1200mm

**Code** X3N121  
**Size (mm)** w1200 d425 h1120  
**Group 1 Price (€)** 162  
**Group 2 Price (€)** 190

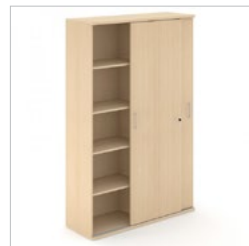

Wardrobe with sliding doors  
5 double levels

**Code** X5S121  
**Size (mm)** w1200 d425 h1874  
**Group 1 Price (€)** 463  
**Group 2 Price (€)** 531



## COMBO STORAGE

## Double Door Cupboards

## Please note:

All cupboards come without a base. Please see page 58 for a range of available bases.



Cupboard  
Full lockable doors  
2 levels - 800mm

**Code** X2C081  
**Size (mm)** w800 d425 h754  
**Group 1 Price (€)** 198  
**Group 2 Price (€)** 226



Cupboard  
Full lockable doors  
2 levels - 1000mm

**Code** X2C101  
**Size (mm)** w1000 d425 h754  
**Group 1 Price (€)** 218  
**Group 2 Price (€)** 249



Cupboard  
Full lockable doors  
3 levels - 800mm

**Code** X3C081  
**Size (mm)** w800 d425 h1120  
**Group 1 Price (€)** 261  
**Group 2 Price (€)** 305



Cupboard  
Full lockable doors  
3 levels - 1000mm

**Code** X3C101  
**Size (mm)** w1000 d425 h1120  
**Group 1 Price (€)** 297  
**Group 2 Price (€)** 352

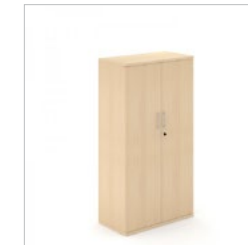

Cupboard  
Full lockable doors  
4 levels

**Code** X4C081  
**Size (mm)** w800 d425 h1508  
**Group 1 Price (€)** 365  
**Group 2 Price (€)** 376



Cupboard  
Full lockable doors  
5 levels - 800mm

**Code** X5C081  
**Size (mm)** w800 d425 h1874  
**Group 1 Price (€)** 372  
**Group 2 Price (€)** 424



Cupboard  
Full lockable doors  
5 levels - 1000mm

**Code** X5C101  
**Size (mm)** w1000 d425 h1874  
**Group 1 Price (€)** 420  
**Group 2 Price (€)** 487



Cupboard  
Full lockable doors  
5 levels - 1200mm

**Code** X5C121  
**Size (mm)** w1200 d425 h1874  
**Group 1 Price (€)** 503  
**Group 2 Price (€)** 594



Cupboard with metal pull-out hanging rail  
5 levels

**Code** X5C083  
**Size (mm)** w800 d425 h1874  
**Group 1 Price (€)** 341  
**Group 2 Price (€)** 392



Cupboard with metal pull-out hanging rail  
5 levels

**Code** X5C082  
**Size (mm)** w800 d600 h1874  
**Group 1 Price (€)** 412  
**Group 2 Price (€)** 475



Cupboard  
Full lockable doors  
6 levels

**Code** X6C081  
**Size (mm)** w800 d425 h2240  
**Group 1 Price (€)** 448  
**Group 2 Price (€)** 519



Cupboard  
Full lockable doors  
6 levels

**Code** X6C101  
**Size (mm)** w1000 d425 h2240  
**Group 1 Price (€)** 499  
**Group 2 Price (€)** 574



Cupboard  
Full lockable doors  
6 levels

**Code** X6C121  
**Size (mm)** w1200 d425 h2240  
**Group 1 Price (€)** 586  
**Group 2 Price (€)** 693



Left hand cupboard  
Full lockable door  
5 levels

**Code** X5C061  
**Size (mm)** w600 d425 h1874  
**Group 1 Price (€)** 273  
**Group 2 Price (€)** 317



Right hand cupboard  
Full lockable door  
5 levels

**Code** X5C062  
**Size (mm)** w600 d425 h1874  
**Group 1 Price (€)** 273  
**Group 2 Price (€)** 317



Left hand cupboard with metal pull-out hanging rail  
5 levels

**Code** X5C063  
**Size (mm)** w600 d425 h1874  
**Group 1 Price (€)** 257  
**Group 2 Price (€)** 301



## COMBO STORAGE

## Single Door Cupboards



Right hand cupboard with metal pull-out hanging rail 5 levels

**Code** X5C064  
**Size (mm)** w600 d425 h1874  
**Group 1 Price (€)** 257  
**Group 2 Price (€)** 301



Left hand cupboard Full lockable door 6 levels

**Code** X6C061  
**Size (mm)** w600 d425 h2240  
**Group 1 Price (€)** 368  
**Group 2 Price (€)** 416



Right hand cupboard Full lockable door 6 levels

**Code** X6C062  
**Size (mm)** w600 d425 h2240  
**Group 1 Price (€)** 368  
**Group 2 Price (€)** 416

## Wardrobes

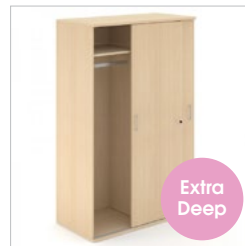

Wardrobe with metal hanging rail

**Code** X5S124  
**Size (mm)** w1200 d600 h1874  
**Group 1 Price (€)** 515  
**Group 2 Price (€)** 598



Wardrobe with metal pull-out hanging rail Requires X0Z009 or X0Z010

**Code** X5C122  
**Size (mm)** w1200 d425 h1874  
**Group 1 Price (€)** 495  
**Group 2 Price (€)** 582



Wardrobe with metal pull-out hanging rail Requires X0Z009 or X0Z010

**Code** X5C123  
**Size (mm)** w1200 d425 h1874  
**Group 1 Price (€)** 487  
**Group 2 Price (€)** 570



Wardrobe with sliding doors metal pull-out hanging rail

**Code** X5S122  
**Size (mm)** w1200 d425 h1874  
**Group 1 Price (€)** 451  
**Group 2 Price (€)** 519



Wardrobe with sliding doors metal pull-out hanging rail

**Code** X5S123  
**Size (mm)** w1200 d425 h1874  
**Group 1 Price (€)** 440  
**Group 2 Price (€)** 507



## Combo Plus Desk Height Storage



Cupboard with tambour lock doors and 1 height adj. shelf

**Code** U2T080  
**Size (mm)** w800 d475 h700  
**Group 1 Price (€)** 333  
**Group 2 Price (€)** 348



Cupboard with 1 height adjustable shelf

**Code** U2N080  
**Size (mm)** w800 d475 h700  
**Group 1 Price (€)** 123  
**Group 2 Price (€)** 143



Cupboard with lockable doors and 1 height adjustable shelf

**Code** U2C080  
**Size (mm)** w800 d475 h700  
**Group 1 Price (€)** 202  
**Group 2 Price (€)** 226



Top for 1640mm deep benches (U2N080 and U2C080)

**Code** U0Z020  
**Size (mm)** w820 d475 h25  
**Group 1 Price (€)** 28  
**Group 2 Price (€)** 32

## Combo Plus Storage



Cupboard with tambour doors and lock only

**Code** U2T101  
**Size (mm)** w1000 d475 h754  
**Group 1 Price (€)** 364  
**Group 2 Price (€)** 388



Cupboard with tambour doors and lock only

**Code** U3T101  
**Size (mm)** w1000 d475 h1120  
**Group 1 Price (€)** 487  
**Group 2 Price (€)** 519



Cupboard with tambour doors and lock only Requires U0Z012

**Code** U4T101  
**Size (mm)** w1000 d475 h1508  
**Group 1 Price (€)** 665  
**Group 2 Price (€)** 709



Cupboard with tambour doors and lock only Requires U0Z012

**Code** U5T101  
**Size (mm)** w1000 d475 h1874  
**Group 1 Price (€)** 685  
**Group 2 Price (€)** 717

## Please note:

All Combo Plus storage excludes internal accessories. Choose accessories on page 59.

Select base options on page 58.



Cupboard with lock, no shelves

**Code** U2C100  
**Size (mm)** w1000 d475 h754  
**Group 1 Price (€)** 218  
**Group 2 Price (€)** 246



Cupboard with lock, no shelves

**Code** U3C100  
**Size (mm)** w1000 d475 h1120  
**Group 1 Price (€)** 257  
**Group 2 Price (€)** 293



Cupboard with lock, no shelves Requires U0Z013

**Code** U4C100  
**Size (mm)** w1000 d475 h1508  
**Group 1 Price (€)** 305  
**Group 2 Price (€)** 352



Cupboard with lock, no shelves Requires U0Z013

**Code** U5C100  
**Size (mm)** w1000 d475 h1874  
**Group 1 Price (€)** 360  
**Group 2 Price (€)** 412



Bookcase without shelves

**Code** U2N100  
**Size (mm)** w1000 d475 h754  
**Group 1 Price (€)** 123  
**Group 2 Price (€)** 139



Bookcase without shelves

**Code** U3N100  
**Size (mm)** w1000 d475 h1120  
**Group 1 Price (€)** 143  
**Group 2 Price (€)** 162

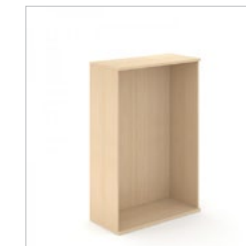

Bookcase without shelves Requires U0Z013

**Code** U4N100  
**Size (mm)** w1000 d475 h1508  
**Group 1 Price (€)** 166  
**Group 2 Price (€)** 190



Bookcase without shelves Requires U0Z013

**Code** U5N100  
**Size (mm)** w1000 d475 h1874  
**Group 1 Price (€)** 194  
**Group 2 Price (€)** 222

## COMBO PLUS STORAGE

# COMBO STORAGE - BASE OPTIONS



## Plinths - 80mm high

Code	Description	Group 1 Price (\$)	Group 2 Price (\$)
XOZ060	Plinth for 600mm wide and 425mm deep storage	20	24
XOZ080	Plinth for 800mm wide and 425mm deep storage	24	28
XOZ081	Plinth for 800mm wide and 600mm deep storage	24	28
XOZ100	Plinth for 1000mm wide and 425mm deep storage	28	32
XOZ101	Plinth for 1000mm wide and 475mm deep storage	32	40
XOZ120	Plinth for 1200mm wide and 425mm deep storage	32	40
XOZ121	Plinth for 1200mm wide and 600mm deep storage	36	44

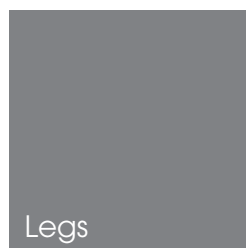

## Metal Legs (4 pcs.)

Code	Description	Price (\$)
XOZ004	Metal legs for 600/800/1000mm wide storage	24
XOZ005	Metal legs and 1 support leg for 1200mm wide storage	28

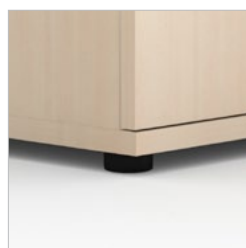
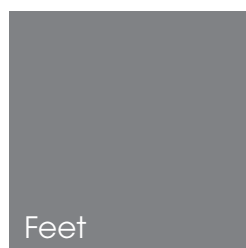

## Plastic Feet

Code	Description	Price (\$)
XOZ013	Plastic feet 20mm (4 pcs.) for 600/800/1000mm wide storage	7
XOZ014	Plastic feet 40mm (5 pcs.) for 1200mm wide storage	7
XOZ015	Plastic feet 40mm for 600/800/1000mm wide storage	15

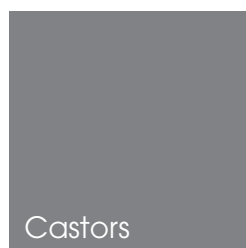

## Castors (4 pcs.)

Code	Description	Price (\$)
XOZ006	Castors (4 pcs, 2 with brakes) for storage 800 mm wide, 3 level height	69
XOZ007	Castors (5 pcs, 2 of them with brakes) for storage 1000-1600 mm wide and up to 3 level height	87

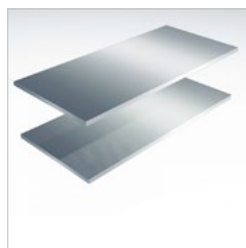

Metal counterweight for storage with metal legs or plastic feet (X5C063, X5C064, X5F081)

Code	XOZ008
Price (\$)	138



Metal counterweight for storage with metal legs or plastic feet (X5C122, X5C123)

Code	XOZ009
Price (\$)	168



Counterweight for storage X5C063, X5C064, X5C122, X5C123 with plinth

Code	XOZ010
Price (\$)	44



Counterweight for storage X5F081 with plinth

Code	XOZ011
Price (\$)	66



## Replacement keys

Code	Description	Price (\$)
ZZZ058	Master Key	18
ZZZ059	Removal Key	15

# COMBO STORAGE ACCESSORIES



## Shelves for Combo Plus Storage

Code	Description	Group 1 Price (\$)	Group 2 Price (\$)
UOZ001	w842 d410 h25 - For Combo Plus tambour door cupboards	20	24
UOZ002	w842 d410 h25 - For Combo Plus tambour door cupboards (Pk.2)	36	44
UOZ012	w844 d410 h25 - Fixed shelf for Combo Plus tambour door cupboards	24	28
UOZ010	w962 d410 h25 - For Combo Plus bookcases & double door cupboards	24	28
UOZ011	w962 d410 h25 - For Combo Plus bookcases & double door cupboards (Pk.2)	48	55
UOZ013	w962 d410 h25 - Fixed shelf for Combo Plus bookcases & double door cupboards	28	32



## Lateral filing shelf with black metal holder for Combo Plus storage

Code	Description	Group 1 Price (\$)	Group 2 Price (\$)
UOZ003	w842 d410 h25 - For Combo Plus tambour door cupboards	79	91
UOZ014	w962 d410 h25 - For Combo Plus bookcases & double door cupboards	87	91



## Shelf with 5 chromed dividers for Combo Plus storage

Code	Description	Group 1 Price (\$)	Group 2 Price (\$)
UOZ008	w842 d410 h25 - For Combo Plus tambour door cupboards	44	48
UOZ015	w962 d410 h25 - For Combo Plus bookcases & double door cupboards	51	55



## Lateral filing cradle for 475mm Combo Plus storage

Code	Description	Price (\$)
UOZ007	w842 d410 h25 - For Combo Plus tambour door cupboards	47
UOZ019	w962 d410 h25 - For Combo Plus bookcases & double door cupboards	55



## Pull-out black metal filing cradles (suitable for A4 filing) for 1000mm wide Combo storage

Code	Description	Price (\$)
HFTD101	w842 d350 h95 - For For Combo Plus tambour door cupboards	126
HFDD101	Filing cradle for Combo & Combo Plus double door cupboards	126
HFAT	Anti-tilt mechanism (1 required per extra pull-out cradle)	16



## Fabric back panel for cabinets

Code	Description	Group 1 Price (\$)	Group 2 Price (\$)
XOZ071	w961 d703 - For use with X2N101, X2C101, X2F101, X2T101, X2S101, U2T101, U2N100, U2C100.	75	131
XOZ103	w961 d1069 - For use with X3S101, X3T101, X3C101, U3T101, U3N100, U3C100.	103	166



## Whiteboard back panel for Combo storage

Code	Description	Price (\$)
XOZ070	w961 d703 - For use with X2N101, X2C101, X2F101, X2T101, X2S101, U2T101, U2N100, U2C100.	79
XOZ102	w961 d1069 - For use with X3S101, X3T101, X3C101, U3T101, U3N100, U3C100.	119



## SELECT STORAGE

A modular storage system for modern work spaces.

Easily combine your storage units by fixing one on the top of the other with special stickers. The principle is as simple as putting together LEGO. Select storage can be adapted to the changing needs of your work environment.



### Bookcases

**Please note:**

All cupboards come without a base. Please see page 65 for a range of available bases.

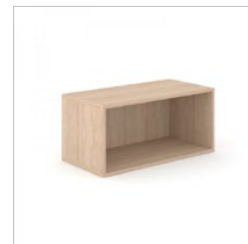

Bookcase  
No divider - 800mm

**Code** C1N080  
**Size (mm)** w800 d400 h370  
**Price (€)** 60

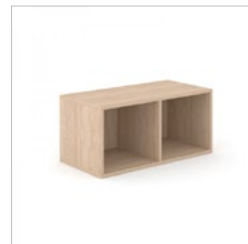

Bookcase  
1 divider - 800mm

**Code** C1N081  
**Size (mm)** w800 d400 h370  
**Price (€)** 68

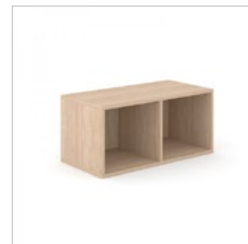

Bookcase  
1 divider - 1000mm

**Code** C1N100  
**Size (mm)** w1000 d400 h370  
**Price (€)** 72



Bookcase  
2 dividers - 1200mm

**Code** C1N120  
**Size (mm)** w1200 d400 h370  
**Price (€)** 96

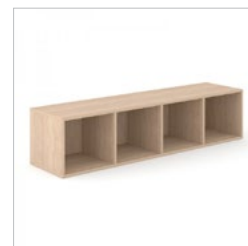

Bookcase  
3 dividers - 1600mm

**Code** C1N160  
**Size (mm)** w1600 d400 h370  
**Price (€)** 120

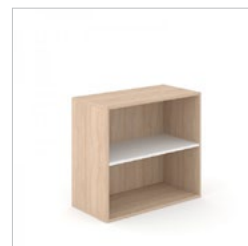

Bookcase  
1 shelf - 800mm

**Code** C2N080  
**Size (mm)** w800 d400 h720  
**Price (€)** 104

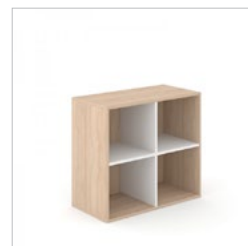

Bookcase  
1 shelf 1 divider - 800mm

**Code** C2N081  
**Size (mm)** w800 d400 h720  
**Price (€)** 120

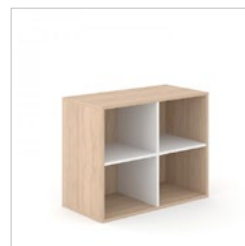

Bookcase  
1 shelf 1 divider - 1000mm

**Code** C2N100  
**Size (mm)** w1000 d400 h720  
**Price (€)** 136

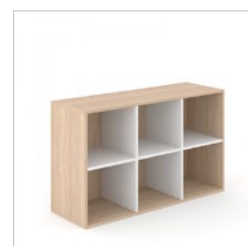

Bookcase  
1 shelf 2 dividers - 1200mm

**Code** C2N120  
**Size (mm)** w1200 d400 h720  
**Price (€)** 176

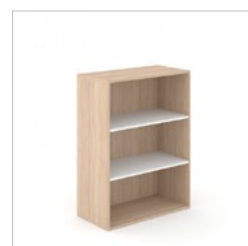

Bookcase  
2 fixed shelves - 800mm

**Code** C3N080  
**Size (mm)** w800 d400 h1075  
**Price (€)** 144

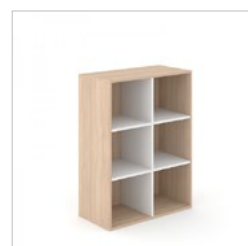

Bookcase  
2 shelves 1 divider - 800mm

**Code** C3N081  
**Size (mm)** w800 d400 h1075  
**Price (€)** 176

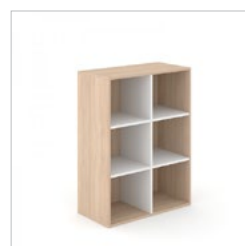

Bookcase  
2 shelves 1 divider - 1000mm

**Code** C3N100  
**Size (mm)** w1000 d400 h1075  
**Price (€)** 196



Bookcase  
2 shelves 2 dividers - 600mm

**Code** C3N120  
**Size (mm)** w1200 d400 h1075  
**Price (€)** 249



Bookcase  
3 fixed shelves - 800mm

**Code** C4N080  
**Size (mm)** w800 d400 h1425  
**Price (€)** 188

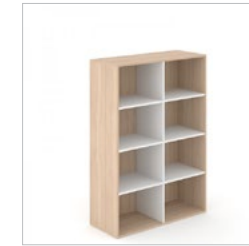

Bookcase  
3 shelves 1 divider - 1000mm

**Code** C4N100  
**Size (mm)** w1000 d400 h1425  
**Price (€)** 261



Shelf unit  
3 shelves 1 divider - 1200mm

**Code** C4N120  
**Size (mm)** w1200 d400 h1425  
**Price (€)** 281

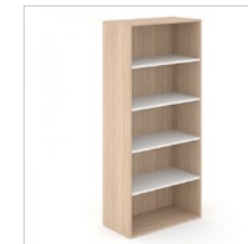

Bookcase  
4 fixed shelves - 800mm

**Code** C5N080  
**Size (mm)** w800 d400 h1780  
**Price (€)** 229

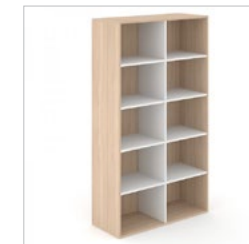

Bookcase  
4 shelves 1 divider - 1000mm

**Code** C5N100  
**Size (mm)** w1000 d400 h1780  
**Price (€)** 309

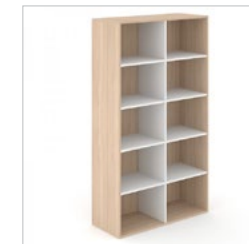

Bookcase  
4 shelves 1 divider - 1200mm

**Code** C5N120  
**Size (mm)** w1200 d400 h1780  
**Price (€)** 341

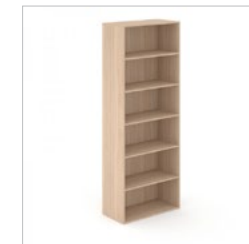

Bookcase  
5 fixed shelves - 800mm

**Code** C6N080  
**Size (mm)** w800 d400 h2130  
**Price (€)** 277

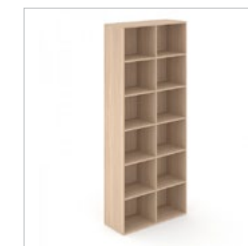

Bookcase  
5 shelves 1 divider - 1000mm

**Code** C6N100  
**Size (mm)** w1000 d400 h2130  
**Price (€)** 377

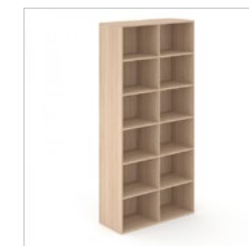

Bookcase  
5 shelves 1 divider - 1200mm

**Code** C6N120  
**Size (mm)** w1200 d400 h2130  
**Price (€)** 421

### Sliding Door Cupboards



Cupboard with 1 sliding door, 2 sections - 800mm

**Code** C1S080  
**Size (mm)** w800 d400 h370  
**Price (€)** 88

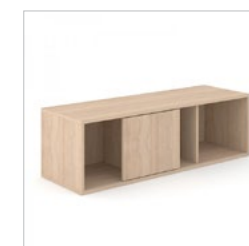

Cupboard with 1 sliding door, 3 sections - 1200mm

**Code** C1S120  
**Size (mm)** w1200 d400 h370  
**Price (€)** 116

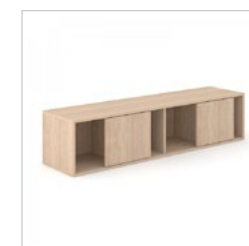

Cupboard with 2 sliding doors, 4 sections - 1600mm

**Code** C1S160  
**Size (mm)** w1600 d400 h370  
**Price (€)** 164

## SELECT STORAGE

## SELECT STORAGE

## Sliding Door Cupboards

## Please note:

All cupboards come without a base. Please see page 65 for a range of available bases.



Cupboard with lockable sliding doors, 4 sections - 800mm  
**Code** C2S080  
**Size (mm)** w800 d400 h720  
**Price (€)** 221



Cupboard with lockable sliding doors, 4 sections - 1000mm  
**Code** C2S100  
**Size (mm)** w1000 d400 h720  
**Price (€)** 245

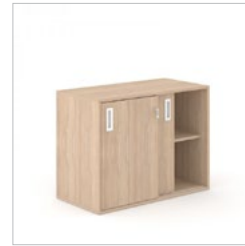

Cupboard with lockable sliding doors, 4 sections - 1200mm  
**Code** C2S120  
**Size (mm)** w1200 d400 h720  
**Price (€)** 261



Cupboard with lockable sliding doors, 4 sections - 1600mm  
**Code** C2S160  
**Size (mm)** w1600 d400 h720  
**Price (€)** 317

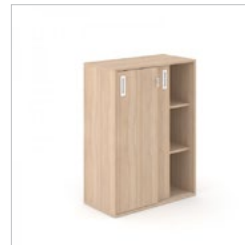

Cupboard with lockable sliding doors, 6 sections - 800mm  
**Code** C3S080  
**Size (mm)** w800 d400 h1075  
**Price (€)** 261

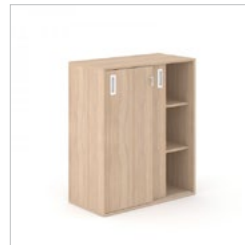

Cupboard with lockable sliding doors, 6 sections - 1000mm  
**Code** C3S100  
**Size (mm)** w1000 d400 h1075  
**Price (€)** 301

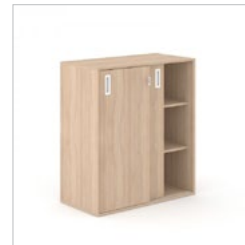

Cupboard with lockable sliding doors, 6 sections - 1200mm  
**Code** C3S120  
**Size (mm)** w1200 d400 h1075  
**Price (€)** 333

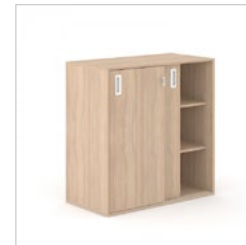

Cupboard with lockable sliding doors, 6 sections - 1600mm  
**Code** C3S160  
**Size (mm)** w1600 d400 h1075  
**Price (€)** 401

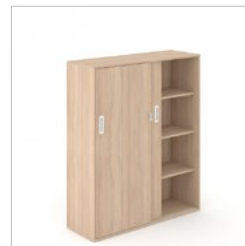

Cupboard with lockable sliding doors, 8 sections - 1200mm  
**Code** C4S120  
**Size (mm)** w1200 d400 h1425  
**Price (€)** 421

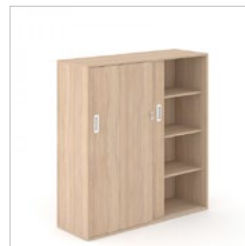

Cupboard with lockable sliding doors, 8 sections - 1600mm  
**Code** C4S160  
**Size (mm)** w1600 d400 h1425  
**Price (€)** 497

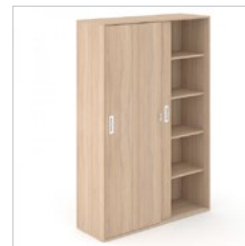

Cupboard with lockable sliding doors, 10 sections - 1200mm  
**Code** C5S120  
**Size (mm)** w1200 d400 h1780  
**Price (€)** 477

## Wardrobes

## Please note:

All bookcases come without a base. Please see page 65 for a range of available bases.

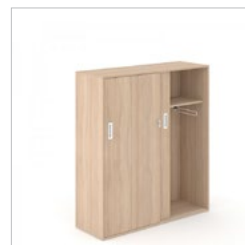

Wardrobe with lockable sliding doors 1 shelf and metal pull out rails  
**Code** C4S121  
**Size (mm)** w1200 d400 h1425  
**Price (€)** 397

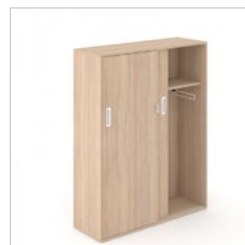

Wardrobe with lockable sliding doors 1 shelf and metal pull out rails  
**Code** C5S121  
**Size (mm)** w1200 d400 h1780  
**Price (€)** 441

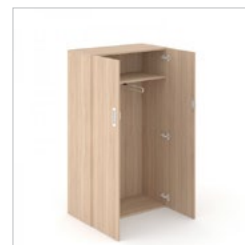

Wardrobe with lockable doors 1 shelf and metal pull out rail - 800mm  
**Code** C4C082  
**Size (mm)** w800 d420 h1425  
**Price (€)** 313

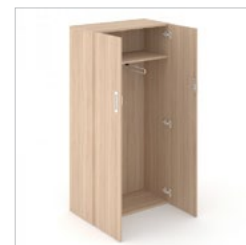

Wardrobe with non lockable doors, 1 shelf and metal pull out rail - 800mm  
**Code** C5C082  
**Size (mm)** w800 d420 h1780  
**Price (€)** 377

## SELECT STORAGE

## Double door cupboards with open top section

## Please note:

All cupboards come without a base. Please see page 65 for a range of available bases.



Cupboard with lockable lower doors 1 shelf  
**Code** C2H080  
**Size (mm)** w800 d420 h720  
**Price (€)** 233

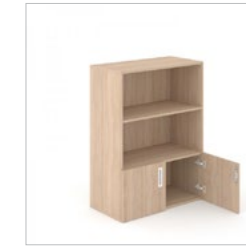

Cupboard with lockable lower doors 2 shelves  
**Code** C3H080  
**Size (mm)** w800 d420 h1075  
**Price (€)** 269



Cupboard with lockable lower doors 3 shelves  
**Code** C4H080  
**Size (mm)** w800 d420 h1425  
**Price (€)** 321



Cupboard with lockable lower doors 4 shelves  
**Code** C5H080  
**Size (mm)** w800 d420 h1780  
**Price (€)** 357



Cupboard with lockable lower doors, 5 shelves  
**Code** C6H080  
**Size (mm)** w800 d420 h2130  
**Price (€)** 409



## Double Door Cupboards

## Please note:

All cupboards come without a base. Please see page 65 for a range of available bases.

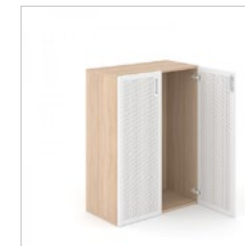

Cupboard with lockable acoustic doors - 800mm  
**Code** C3C082  
**Size (mm)** w800 d420 h1075  
**Price (€)** 962

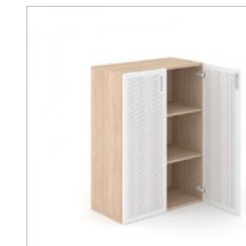

Cupboard with lockable acoustic doors, 2 shelves - 800mm  
**Code** C3C083  
**Size (mm)** w800 d420 h1075  
**Price (€)** 998



Cupboard with lockable doors - 800mm  
**Code** C2C080  
**Size (mm)** w800 d420 h720  
**Price (€)** 225



Cupboard with lockable doors, 1 shelf - 800mm  
**Code** C2C081  
**Size (mm)** w800 d420 h720  
**Price (€)** 241

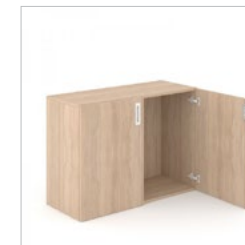

Cupboard with lockable doors - 1000mm  
**Code** C2C100  
**Size (mm)** w1000 d420 h720  
**Price (€)** 249



Cupboard with lockable doors, 1 shelf - 1000mm  
**Code** C2C101  
**Size (mm)** w1000 d420 h720  
**Price (€)** 273

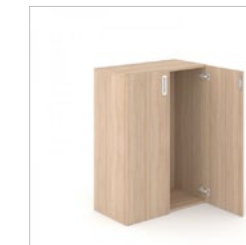

Cupboard with lockable doors - 800mm  
**Code** C3C080  
**Size (mm)** w800 d420 h1075  
**Price (€)** 257

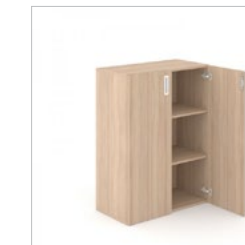

Cupboard with lockable doors, 2 shelves - 800mm  
**Code** C3C081  
**Size (mm)** w800 d420 h1075  
**Price (€)** 293



## SELECT STORAGE

### Double Door Cupboards

**Please note:**

All cupboards come without a base. Please see page 65 for a range of available bases.



Cupboard with lockable doors - 1000mm

**Code** C3C100  
**Size (mm)** w1000 d420 h1075  
**Price (€)** 285

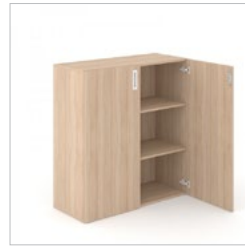

Cupboard with lockable doors, 2 shelves - 1000mm

**Code** C3C101  
**Size (mm)** w1000 d420 h1075  
**Price (€)** 329



Cupboard with lockable doors - 800mm

**Code** C4C080  
**Size (mm)** w800 d425 h1425  
**Price (€)** 321

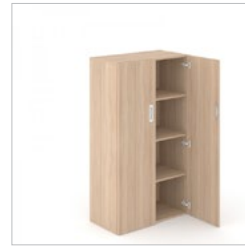

Cupboard with lockable doors, 3 shelves - 800mm

**Code** C4C081  
**Size (mm)** w800 d425 h1425  
**Price (€)** 365

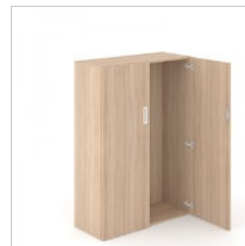

Cupboard with lockable doors - 1000mm

**Code** C4C100  
**Size (mm)** w1000 d420 h1425  
**Price (€)** 349

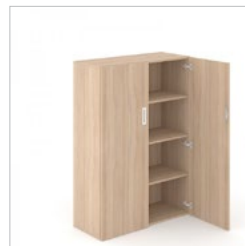

Cupboard with lockable doors, 3 shelves - 1000mm

**Code** C4C101  
**Size (mm)** w1000 d420 h1425  
**Price (€)** 417

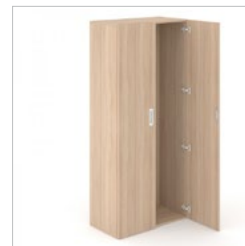

Cupboard with lockable doors - 1000mm

**Code** C5C080  
**Size (mm)** w800 d420 h1780  
**Price (€)** 385

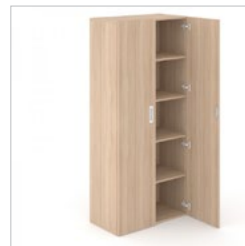

Cupboard with lockable doors, 4 shelves - 800mm

**Code** C5C081  
**Size (mm)** w800 d420 h1780  
**Price (€)** 441

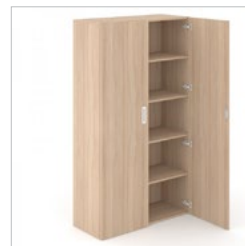

Cupboard with lockable doors, 4 shelves - 1000mm

**Code** C5C101  
**Size (mm)** w1000 d430 h1780  
**Price (€)** 497

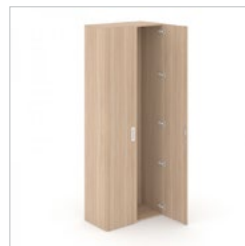

Cupboard with lockable doors - 800mm

**Code** C6C080  
**Size (mm)** w800 d420 h2130  
**Price (€)** 453

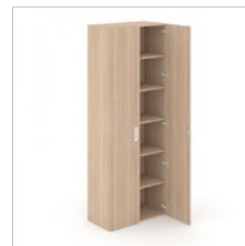

Cupboard with lockable doors, 5 shelves - 800mm

**Code** C6C081  
**Size (mm)** w800 d420 h2130  
**Price (€)** 525



Cupboard with lockable doors - 1000mm

**Code** C6C100  
**Size (mm)** w1000 d420 h2130  
**Price (€)** 497



Cupboard with lockable doors, 5 shelves - 1000mm

**Code** C6C101  
**Size (mm)** w1000 d420 h2130  
**Price (€)** 613



### Base options



#### Wooden plinths

Code	Description	Price (€)
COZ080	w800 d400 h80	24
COZ100	w1000 d400 h80	28
COZ120	w1200 d400 h80	32
COZ160	w1600 d400 h80	36



#### Metal plinths

Code	Description	Price (€)
COZ081	w800 d400 h40	40
COZ101	w1000 d400 h40	44
COZ121	w1200 d400 h40	48
COZ161	w1600 d400 h40	52



#### Plastic feet

Code	Description	Price (€)
COZ001	Ø50, h17	8
COZ002	Ø50, h17	8



#### Metal Legs

Code	Description	Price (€)
COZ003	w400 d153 h80 - Metal legs	16
COZ004	w400 d153 h80 - Metal legs	16
COZ082	w800 d400 h150 - Metal frame with legs	32
COZ102	w1000 d400 h150 - Metal frame with legs	36
COZ122	w1200 d400 h150 - Metal frame with legs	44
COZ162	w1600 d400 h150 - Metal frame with legs	44



#### Natural ash solid wood legs

Code	Description	Price (€)
COZ005	w400 d160 h150 - (4 pcs.) for 800/1000mm wide cabinets	213
COZ006	w400 d160 h150 - (5 pcs.) for 1200/1600mm wide cabinets	237



#### Castors

Code	Description	Price (€)
XOZ006	h90 - (4 pcs. 2 with brakes) for cabinets 800 mm wide	69
XOZ007	h90 - (5 pcs. 2 with brakes) for cabinets 1000 - 1600 mm wide	87

### Pigeon hole Inserts



#### Pigeon holes

Code	Dimensions	Price (€)
COZ049	w764 d310 h334 - For 800mm wide storage	36
COZ050	w964 d310 h327 - For 1000mm wide storage	40

## SELECT STORAGE ACCESSORIES

### Shelf options



#### Shelf packs

Code	Description	Price (€)
COZ026	Shelf (1 pcs.) for 2H, 800mm wide storage	16
COZ027	Shelves (2 pcs.) for 3H, 800mm wide storage	36
COZ028	Shelves (2pcs.) and fixed shelf for 4H, 800mm wide storage	44
COZ029	Shelves (3pcs.) and fixed shelf for 5H, 800mm wide storage	56
COZ030	Shelf (1 pcs.) for 2H, 1000mm wide storage	24
COZ031	Shelves (2 pcs.) for 3H, 1000mm wide storage	44
COZ032	Shelves (2pcs.) and fixed shelf for 4H, 1000mm wide storage	68
COZ033	Shelves (3pcs.) and fixed shelf for 5H, 1000mm wide storage	84

#### Additional fixed shelves

Code	Description	Price (€)
COZ034	Fixed shelf for 800mm wide storage (1 pcs.)	20
COZ035	Fixed shelf for 1000mm wide storage (1 pcs.)	28



#### Shelf with 7 chrome dividers

Code	Description	Price (€)
COZ036	w764 d379 h200 - For 800mm storage	60
COZ037	w964 d379 h200 - For 1000mm storage	68



#### Metal filing shelves

Code	Description	Price (€)
COZ038	Lateral filing metal shelf for 800mm wide storage with hinged doors (suitable for A4 suspension files)	48
COZ039	Lateral filing metal shelf for 1000mm wide storage with hinged doors (suitable for A4 suspension files)	56



#### Metal shelves

Code	Description	Price (€)
COZ040	For 800mm wide storage with sliding doors	32
COZ041	For 1000mm wide storage with sliding doors	36
COZ042	For 1200mm wide storage with sliding doors	40
COZ043	For 1600mm wide storage with sliding doors	44



### Accessories



Pull-out black metal filing cradle for 800mm wide storage

Code	COZ044
Size (mm)	w762 d350 h95
Price (€)	176



Pull-out black metal filing cradle for 1000mm wide storage

Code	COZ045
Size (mm)	w962 d350 h95
Price (€)	180



Pull out black metal filing cradle with anti-tilt

Code	HFAT
Size (mm)	w762 d350 h95
Price (€)	16



Metal counterweight. Metallic colour.

Code	XOZ020
Size (mm)	w410 d190 h8
Price (€)	128

## SELECT STORAGE ACCESSORIES

### Accessories

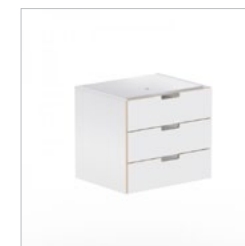

Drawers box

Code	ZTZ005
Size (mm)	w370 d305 h330
Price (€)	196



MFC counterweight  
Should be mounted inside the unit at the rear (2pcs.)

Code	Price (€)
XOZ021 w764 d333 h25	44
XOZ022 w964 d333 h25	52



Plastic drawer (without lock; black colour)

Code	COZ052
Size (mm)	w380 d375 h32
Price (€)	76



Stickers for cabinet fixing onto another (6pcs.)

Code	COZ053
Price (€)	8

### Cushions



Hook-and-loop cushion for cabinets - 790mm

Code	COZ087
Size (mm)	w790 d390 h32
Group 1 Price (€)	104
Group 2 Price (€)	140



Hook-and-loop cushion for cabinets - 990mm

Code	COZ107
Size (mm)	w990 d390 h32
Group 1 Price (€)	108
Group 2 Price (€)	144



Hook-and-loop cushion for cabinets - 1190mm

Code	COZ127
Size (mm)	w1190 d390 h32
Group 1 Price (€)	116
Group 2 Price (€)	152

### Fabric Back Panels



#### Fabric back panels

Code	Size (mm)	Group 1 Price (€)	Group 2 Price (€)
COZ083	w762 h334	32	48
COZ084	w762 h684	44	72
COZ085	w762 h1038	88	132
COZ086	w762 h1389	96	140
COZ103	w962 h334	40	56
COZ104	w962 h684	60	92
COZ105	w962 h1038	104	160
COZ106	w962 h1389	116	172
COZ123	w1162 h334	44	68
COZ124	w1162 h684	72	104
COZ125	w1162 h1038	116	172
COZ126	w573 h1389 (x2)	144	221
COZ163	w1562 h334	52	76
COZ164	w1562 h684	92	136
COZ165	w772 h1038 (x2)	172	261
COZ166	w772 h1389 (x2)	184	281





## SELECT STORAGE LOCKERS

Modular MFC lockers are a versatile solution for secure personal and office storage.

Combine lockers with 2 different door types – the standard and with cut-out for mail or air circulation.

Create colourful combinations and match the doors colour with lockers body.



## SELECT STORAGE LOCKERS

### Locker Tops



Top panel for 450 mm width locker

Code C2C090  
Size (mm) w450 d500 h16  
Price (€) 16



Top panel for 900 mm width lockers

Code C2C091  
Size (mm) w900 d500 h16  
Price (€) 24



Top panel for 1350 mm width lockers

Code C2C092  
Size (mm) w1350 d500 h16  
Price (€) 36



Top panel for 1800 mm width lockers

Code C2C093  
Size (mm) w1800 d500 h16  
Price (€) 44

### Regular Door Lockers

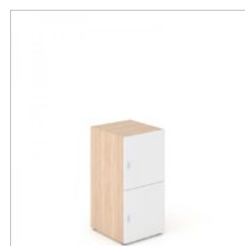

Single width locker with 2 small lockable doors

Code C2C090  
Size (mm) w450 d500 h917  
Group 1 Price (€) 209  
Group 2 Price (€) 289

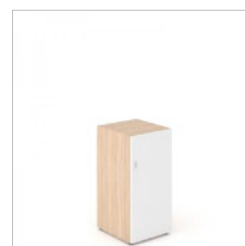

Single width locker with 1 large lockable door

Code C2C091  
Size (mm) w450 d500 h917  
Group 1 Price (€) 148  
Group 2 Price (€) 229

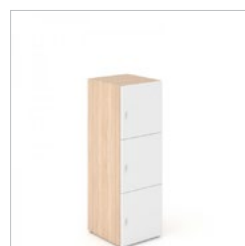

Single width locker with 3 small lockable doors

Code C3C130  
Size (mm) w450 d500 h1367  
Group 1 Price (€) 301  
Group 2 Price (€) 421



Single width locker with 1 small and 1 large lockable door

Code C3C131  
Size (mm) w450 d500 h1367  
Group 1 Price (€) 241  
Group 2 Price (€) 361



Single width locker with 4 small lockable doors

Code C4C180  
Size (mm) w450 d500 h1817  
Group 1 Price (€) 393  
Group 2 Price (€) 553



Single width locker with 2 large lockable doors

Code C4C181  
Size (mm) w450 d500 h1817  
Group 1 Price (€) 281  
Group 2 Price (€) 441



Single width locker with 2 small and 1 large lockable door

Code C4C182  
Size (mm) w450 d500 h1817  
Group 1 Price (€) 337  
Group 2 Price (€) 497

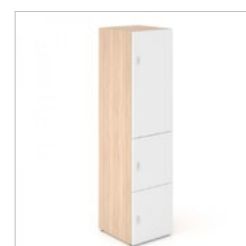

Single width locker with 1 large and 2 small lockable doors

Code C4C183  
Size (mm) w450 d500 h1817  
Group 1 Price (€) 337  
Group 2 Price (€) 497

### Lock Options

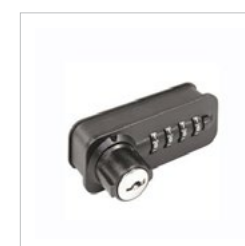

Manual combination lock for personal use

Code BP  
Price (€) 36



Large electronic combination lock for personal or shared use

Code CP/CS  
Price (€) 249



Large electronic keycard lock for personal or shared use

Code DP/DS  
Price (€) 249

**Please note:**  
When ordering lockers with electronic locks CP CS or DP DS, manager key ZZZ331, programming key ZZZ332 must be ordered too.

## SELECT STORAGE LOCKERS

Lockers with  
Cut-Out for  
Mail

Single width locker with 2 small lockable doors (with mail slot)

Code C2C092  
Size (mm) w450 d500 h917  
Group 1 Price (€) 217  
Group 2 Price (€) 297



Single width locker with 1 large lockable door (with mail slot)

Code C2C093  
Size (mm) w450 d500 h917  
Group 1 Price (€) 152  
Group 2 Price (€) 233

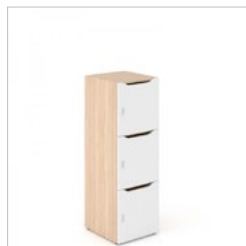

Single width locker with 3 small lockable doors (with mail slot)

Code C3C132  
Size (mm) w450 d500 h1367  
Group 1 Price (€) 313  
Group 2 Price (€) 433



Single width locker with 1 small and 1 large lockable door (with mail slot)

Code C3C133  
Size (mm) w450 d500 h1367  
Group 1 Price (€) 249  
Group 2 Price (€) 369



Single width locker with 4 small lockable doors (with mail slot)

Code C4C184  
Size (mm) w450 d500 h1817  
Group 1 Price (€) 409  
Group 2 Price (€) 569



Single width locker with 2 large lockable doors (with mail slot)

Code C4C185  
Size (mm) w450 d500 h1817  
Group 1 Price (€) 289  
Group 2 Price (€) 449



Single width locker with 2 small and 1 large lockable door (with mail slot)

Code C4C186  
Size (mm) w450 d500 h1817  
Group 1 Price (€) 349  
Group 2 Price (€) 509



Single width locker with 1 large and 2 small lockable doors (with mail slot)

Code C4C187  
Size (mm) w450 d500 h1817  
Group 1 Price (€) 349  
Group 2 Price (€) 509

## Locker carcasses available in 8 standard MFC finishes.

Group 1 price, doors available in 8 standard MFC finishes.

Group 2 price, doors available in 5 new HPL finishes (as shown below).



Grey  
(H12)



Cappuccino  
(H13)



Light yellow  
(H14)



Mint  
(H15)

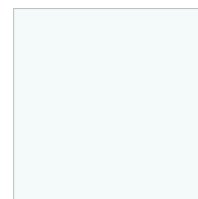

White  
(H70)

## SELECT STORAGE LOCKERS

## Extras

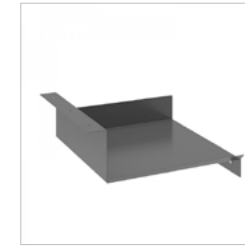

Metal shelf (right)

Code C0Z062  
Size (mm) w20 d28 h62  
Price (€) 40



Metal shelf (central) for doors with mail slot

Code C0Z063  
Size (mm) w20 d28 h62  
Price (€) 44



Metal hook for clothes

Code ZZZ061  
Size (mm) w20 d28 h62  
Price (€) 12

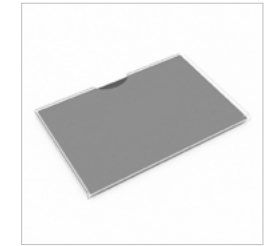

Glued plexiglas name card holder (1 pcs.)

Code ZZZ062  
Size (mm) w60 d90 h1.5  
Price (€) 4



Manager key for electronic locks (recommended 1-2 pcs. per office), 1 pcs.

Code ZZZ331  
Price (€) 80



Programming key for electronic locks (recommended one pcs. per office), 1 pcs.

Code ZZZ332  
Price (€) 104

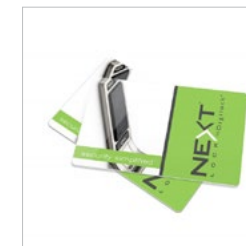

User card for DP DS electronic locks, 1 pcs.

Code ZZZ333  
Price (€) 12



Code finding pin for BP lock (1 pcs.)

Code ZZZ334  
Price (€) 12



Master key (1 pcs.)

Code ZZZ058  
Price (€) 20

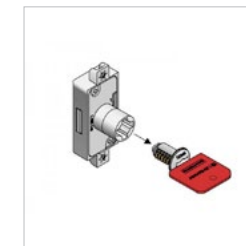

Removal key (1 pcs.)

Code ZZZ059  
Price (€) 16



Cylinder lock with 2 keys

Code ZZZ060  
Price (€) 12





## CURVE RECEPTION DESK

Contemporary lines give a confident, professional impression your visitors are sure to remember.

A first impression is a lasting impression.

Clean, modern look with no sharp corners on the front side to make your office look welcoming yet sophisticated.



Reception unit and desk with 2 round cut outs for cable management. Available in white only. Plinth is polished aluminium colour laminate.

Code	Size (mm)	Price (£)
RCS200	w2000 d800 h1025	1988

Curve  
Reception  
Desk



- › High, curved modesty panel made using CPL
- › Supplied complete with supports and desktop in white MFC
- › Polished aluminium plinth

## VERSA RECEPTION DESKS

Straight, clean, stylish lines mark this simple but effective range of reception fronts to complement the Versa Bench desking range.

Contrasting Perspex® lines define and break up the panels giving a pleasing effect to large or small runs of panels. Please choose your Versa desks from the desking section, then add the panels from here to create your complete reception unit.



Reception  
Panels

Desks need purchasing separately, see page 4.

NB. When L or R is indicated this is as viewed from the front.



### Full height modesty panel - Front only

Code	Size (mm)	Price (£)
RNS100	w1600 d935 h1125	353
RNS101	w1800 d935 h1125	382
RNS203	w3200 d935 h1125	832

### Full height modesty panel - Front and 1 return side

Code	Size (mm)	Hand	Price (£)
RNS201	w3340 d1735 h1125	L	1157
RNS202	w3340 d1735 h1125	R	1157

### Full height modesty panel - Front and both return sides

Code	Size (mm)	Price (£)
RNS200	w3470 d935 h1125	1307



## STOCKHOLM EXECUTIVE FURNITURE

The Stockholm executive range will bring solidity and exclusivity into upper class conference rooms, meeting areas and senior management offices

Extra thick 36mm table tops with a unique, stylish and slim steel leg design are complimented by a range of matching tables and storage solutions.



### Executive Desks



**Executive desk, R/H**  
(with cut out and box for power socket)

Code	Description	MFC Price (€)	Veneer Price (€)
BPA180	w1800 d900 h750, painted frame	1037	1244
	w1800 d900 h750, chrome frame	2102	2313
BPA220	w2200 d900 h750, painted frame	1104	1338
	w2200 d900 h750, chrome frame	2145	2379



**Executive desk, L/H**  
(with cut out and box for power socket)

Code	Description	MFC Price (€)	Veneer Price (€)
BPA181	w1800 d900 h750, painted frame	1037	1244
	w1800 d900 h750, chrome frame	2102	2313
BPA221	w2200 d900 h750, painted frame	1104	1338
	w2200 d900 h750, chrome frame	2145	2379



**Executive desk with modesty panel, R/H**  
(with cut out and box for power socket)

Code	Description	MFC Price (€)	Veneer Price (€)
BPA182	w1800 d900 h750, painted frame	1006	1303
	w1800 d900 h750, chrome frame	1895	2196
BPA222	w2200 d900 h750, painted frame	1069	1427
	w2200 d900 h750, chrome frame	1966	2324



**Executive desk with modesty panel, L/H**  
(with grommet and box for power socket)

Code	Description	MFC Price (€)	Veneer Price (€)
BPA183	w1800 d900 h750, painted frame	1006	1303
	w1800 d900 h750, chrome frame	1895	2196
BPA223	w2200 d900 h750, painted frame	1069	1427
	w2200 d900 h750, chrome frame	1966	2324

## STOCKHOLM EXECUTIVE FURNITURE

### Executive Desks with Pedestal



**Executive desk with fixed pedestal BPF900 on the right**  
(with cut out and box for power socket)

Code	Description	MFC Price (€)	Veneer top/MFC ped Price (€)	All Veneer Price (€)
BPA200	w2040 d1500 h750, painted frame	1814	2020	2633
	w2040 d1500 h750, chrome frame	2976	3186	3799
BPA240	w2440 d1500 h750, painted frame	1880	2114	2726
	w2440 d1500 h750, chrome frame	3019	3253	3865



**Executive desk with fixed pedestal BPF901 on the left**  
(with cutout and box for power socket)

Code	Description	MFC Price (€)	Veneer top/MFC ped Price (€)	All Veneer Price (€)
BPA201	w2040 d1500 h750, painted frame	1814	2020	2633
	w2040 d1500 h750, chrome frame	2976	3186	3799
BPA241	w2440 d1500 h750, painted frame	1880	2114	2726
	w2440 d1500 h750, chrome frame	3019	3253	3865



**Executive desk with modesty panel and fixed pedestal BPF900 on the right**  
(with grommet and box for power socket)

Code	Description	MFC Price (€)	Veneer top/MFC ped Price (€)	All Veneer Price (€)
BPA202	w2040 d1500 h750, painted frame	1782	2079	2691
	w2040 d1500 h750, chrome frame	2769	3069	3682
BPA242	w2440 d1500 h750, painted frame	1845	2204	2816
	w2440 d1500 h750, chrome frame	2839	3198	3810



**Executive desk with modesty panel and fixed pedestal BPF901 on the left**  
(with cut outs and box for power socket)

Code	Description	MFC Price (€)	Veneer top/MFC ped Price (€)	All Veneer Price (€)
BPA203	w2040 d1500 h750, painted frame	1782	2079	2691
	w2040 d1500 h750, chrome frame	2769	3069	3682
BPA243	w2440 d1500 h750, painted frame	1845	2204	2816
	w2440 d1500 h750, chrome frame	2839	3198	3810

### Extras



**Desk Return**

Code	Description	MFC Price (€)	All Veneer Price (€)
BPD140	w1400 d800 h750, painted frame	468	554
	w1400 d800 h750, chrome frame	842	928





## STOCKHOLM EXECUTIVE FURNITURE

Executive  
Pedestals &  
Storage

**Pedestal (one pull-out drawer on the left; 2 drawers on the right, upper drawer lined with genuine leather)**

Code	Description	MFC Price (€)	Veneer Price (€)
BPF900	w900 d600 h517	710	1322



**Pedestal (one pull-out drawer on the right; 2 drawers on the left, upper drawer lined with genuine leather)**

Code	Description	MFC Price (€)	Veneer Price (€)
BPF901	w900 d600 h517	710	1322

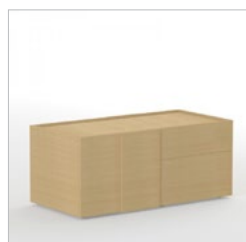

**Pedestal (2 shelves on the left; 2 drawers on the right, upper drawer lined with genuine leather)**

Code	Description	MFC Price (€)	Veneer Price (€)
BPF120	w1200 d600 h517	725	1373

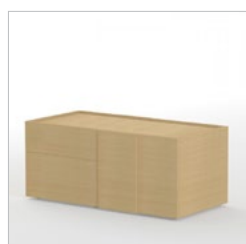

**Pedestal (2 shelves on the right; 2 drawers on the left, upper drawer lined with genuine leather)**

Code	Description	MFC Price (€)	Veneer Price (€)
BPF121	w1200 d600 h517	725	1373

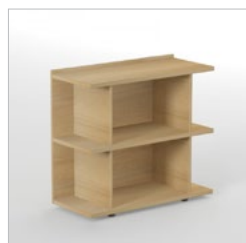

**Bookcase (with 2 shelves)**

Code	Description	MFC Price (€)	Veneer Price (€)
BPE090	w900 d400 h814	207	550

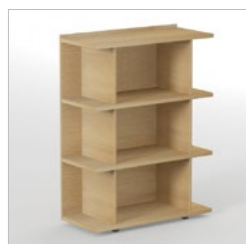

**Bookcase (with 3 shelves)**

Code	Description	MFC Price (€)	Veneer Price (€)
BPE091	w900 d400 h1190	285	772



**Bookcase (with 5 shelves)**

Code	Description	MFC Price (€)	Veneer Price (€)
BPE092	w900 d400 h1942	429	1193

## STOCKHOLM EXECUTIVE FURNITURE

Executive  
Storage

**2 Shelf Cupboard, no locks, soft close drawers**

Code	Description	MFC Price (€)	Veneer Price (€)
BPE093	w900 d425 h814	238	679



**3 Shelf Cupboard, no locks, soft close drawers**

Code	Description	MFC Price (€)	Veneer Price (€)
BPE094	w900 d425 h1190	480	1209



**5 Shelf Cupboard, no locks, soft close drawers**

Code	Description	MFC Price (€)	Veneer Price (€)
BPE095	w900 d425 h1942	768	1931



**Wardrobe with touch latch door (no lock) and open shelves**

Code	Description	MFC Price (€)	Veneer Price (€)
BPE096	w900 d425 h1942	792	1950

Rectangular  
Meeting Tables

**Meeting table, 8 seats, w2400 x d1200 x h750 (with cut out and box for power sockets)**

Code	Description	MFC Price (€)	Veneer Price (€)
CPM240	Painted metal frame	1314	1517
	Chrome frame	2523	2378



**Meeting table, 14 seats, w4200 x d1200 x h750 (with 2 cut outs and boxes for power sockets)**

Code	Description	MFC Price (€)	Veneer Price (€)
CPM420	Painted metal frame	1989	2363
	Chrome frame	3541	3931

Round  
Meeting Tables

**Round meeting table, 3 seats Ø 1200 h750**

Code	Description	MFC Price (€)	Veneer Price (€)
CPM120	Painted metal frame	601	718
	Chrome frame	1131	1248

## PERSPEX DESKTOP SCREENS & MODESTY PANELS

Choose from our range of Perspex screens and modesty panels to match your Versa desking.

All prices include brackets. Please supply layout plans so we can select correct brackets for your requirements. Perspex screens are available in over 75 different colours.



VersaTrack Aluminium 4 Slot Tool Rail



### 4 slot tool rail

Code	Size (mm)	Price (£)
VT/1200-165/TB4	w1200 x h165mm	189
VT/1400-165/TB4	w1400 x h165mm	191
VT/1600-165/TB4	w1600 x h165mm	191
VT/1800-165/TB4	w1800 x h165mm	235

For screen mounted monitor arms see page 102



### 4 slot tool rail with Perspex® screen

Code	Size (mm)	Group 1 Price (£)	Group 2 Price (£)
VP/1200-380/TB4	w1200 x h380mm	305	338
VP/1400-380/TB4	w1400 x h380mm	334	373
VP/1600-380/TB4	w1600 x h380mm	351	395
VP/1800-380/TB4	w1800 x h380mm	410	463

For screen mounted monitor arms see page 102

VersaTrack Screen Hung Accessories  
(For all screen tool rails)



### Screen Hung Accessories

Code	Item	Price (£)
VA/PP	Pencil Pot	18
VA/PH	Phone Holder	17
VA/NH	Name Holder	15
VA/LTA4	Letter Tray A4	21
VA/LTA3	Letter Tray A3	27
VA/TP	Trinket Pot	16

Perspex® Screens Unframed

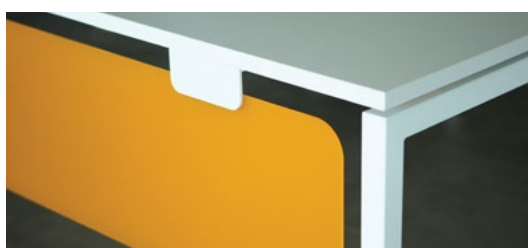

VersaColour™ choice of 75 colours from the UK Perspex® range. Minimum quantity may apply. See page 121.

**Group 1**  
Transparent, opal or opaque

**Group 2**  
Fluorescent, naturals/ vario/glass look, frosted



### Unframed Perspex® screen/modesty panel

Code	Size (mm)	For Desk Width (mm)	Group 1 Price (£)	Group 2 Price (£)
SPS120	w1050 h340	1200	150	183
SPS140	w1250 h340	1400	178	217
SPS160	w1450 h340	1600	194	239
SPS180	w1650 h340	1800	210	263

All colour choices can be viewed on the [formetiq.com](http://formetiq.com) website.

### Unframed Perspex® screen for Back-to-Back Bench

Code	Size (mm)	For Desk Width (mm)	Group 1 Price (£)	Group 2 Price (£)
SPB120	w1050 h340	1200	151	183
SPB140	w1250 h340	1400	178	217
SPB160	w1450 h340	1600	194	239
SPB180	w1650 h340	1800	210	263

All colour choices can be viewed on the [formetiq.com](http://formetiq.com) website.

## PERSPEX DESKTOP SCREENS & MODESTY PANELS

Perspex® Sliding top Screens Unframed

VersaColour™ choice of 75 colours from the UK Perspex® range. Minimum quantity may apply. See page 121.

**Group 1**  
Transparent, opal or opaque

**Group 2**  
Fluorescent, naturals/ vario/glass look, frosted



### Unframed Perspex screen/modesty panel for Versa single desk with sliding top

Code	Size (mm)	For Desk Width (mm)	Group 1 Price (£)	Group 2 Price (£)
SL-SPS120	w1050 h340	1200	150	183
SL-SPS140	w1250 h340	1400	178	217
SL-SPS160	w1450 h340	1600	194	239
SL-SPS180	w1650 h340	1800	210	263

### Unframed Perspex screen for back-to-back Versa bench desk with sliding tops

Code	Size (mm)	For Desk Width (mm)	Group 1 Price (£)	Group 2 Price (£)
SL-SPB120	w1050 h340	1200	151	183
SL-SPB140	w1250 h340	1400	178	217
SL-SPB160	w1450 h340	1600	194	239
SL-SPB180	w1650 h340	1800	210	263

## Choose from our range of Versacolour Perspex

Select from our large range of opaques, solid colours, mineral colours, frosted colours, fluorescent colours and more. The range listed below has no minimum order quantity.

All other colours must be ordered at a minimum quantity of 5 screens per order, the full range of Perspex colours can be found on page 121.

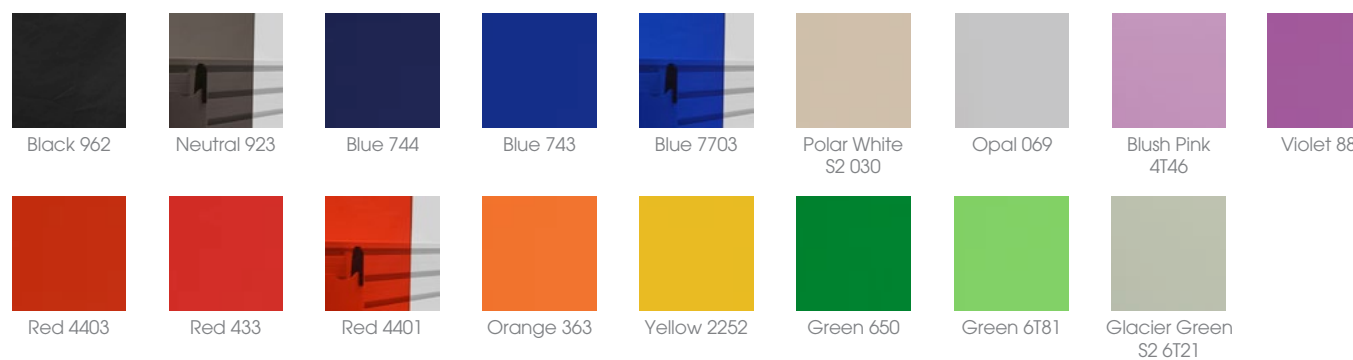

## FREE Versacolour Perspex swatch

All registered Formetiq and Metalicon dealers qualify for a free Versacolour perspex swatch, allowing your customers to see, touch and colourmatch perspex screens for their workspace.

Visit [formetiq.com/swatch](http://formetiq.com/swatch) to find out more.





## FABRIC DESKTOP SCREENS

A wide range of fabric screens and modesty panels to enhance any workplace environment.

All prices include brackets. Please supply layout plans so we can select correct brackets for your requirements. Aluminium frames and PVC edging available in a choice of white, silver or black.

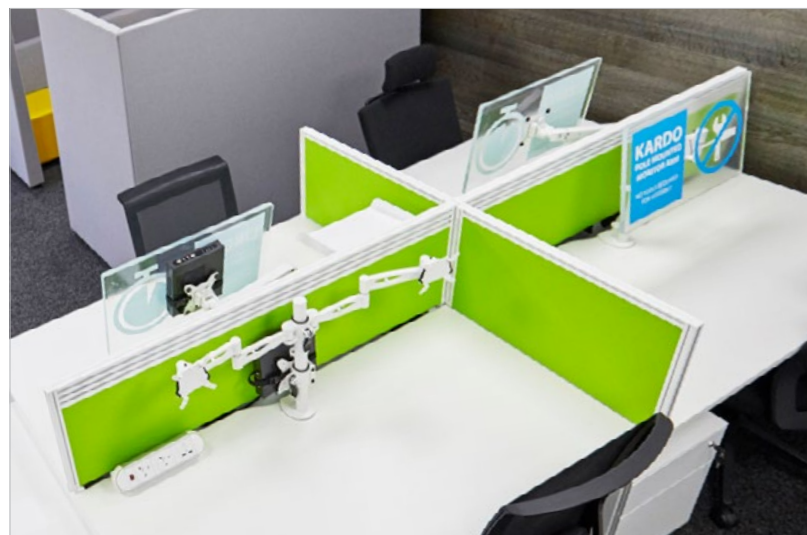

### IMPORTANT NOTES: FABRIC SCREENS

Group 1 Fabric Full Camira Cara range  
Group 2 Fabric Full Camira Lucia range

Other fabrics - POA  
Pinnable screens - POA  
Wave/curved top screens - POA



Fabric Screens  
Aluminium End Posts



Fabric screens aluminium end posts, Plastic top rail

Code	Size (mm)	Group 1 Price (\$)	Group 2 Price (\$)
AP/705-385/ST	w700 h380	128	148
AP/785-380/ST	w700 h380	118	136
AP/800-380/ST	w800 h380	118	147
AP/805-385/ST	w800 h380	128	148
AP/1200-380/ST	w1200 h380	142	177
AP/1400-380/ST	w1400 h380	148	192
AP/1600-380/ST	w1600 h380	171	220
AP/1800-380/ST	w1800 h380	184	237

Aluminium  
Frame Fabric  
Screens



Aluminium framed fabric desk screen - Single tool rail

Code	Size (mm)	Group 1 Price (\$)	Group 2 Price (\$)
AL/705-385/ST-TB1	w705 h380	138	158
AL/785-380/ST-TB1	w785 h380	129	147
AL/800-380/ST-TB1	w800 h380	129	147
AL/805-385/ST-TB1	w800 h380	138	158
AL/1200-380/ST-TB1	w1200 h380	152	177
AL/1400-380/ST-TB1	w1400 h380	163	192
AL/1600-380/ST-TB1	w1600 h380	187	220
AL/1800-380/ST-TB1	w1800 h380	200	237

Aluminium framed fabric desk screen - Triple tool rail

Code	Size (mm)	Group 1 Price (\$)	Group 2 Price (\$)
AL/785-380/ST-TB3	w785 h380	148	166
AL/800-380/ST-TB3	w800 h380	148	166
AL/1200-380/ST-TB3	w1200 h380	177	203
AL/1400-380/ST-TB3	w1400 h380	202	231
AL/1600-380/ST-TB3	w1600 h380	226	259
AL/1800-380/ST-TB3	w1800 h380	257	293



PVC Edged  
Fabric  
Screens

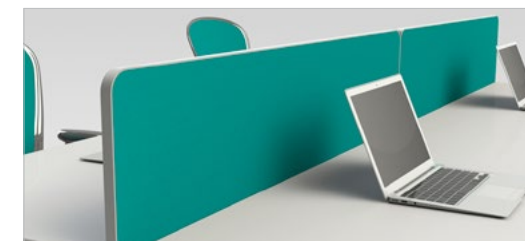

Fabric Edged  
Screen

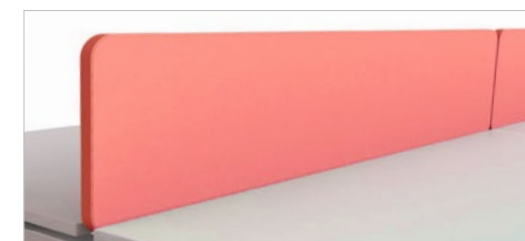

Fabric  
Screen with  
Stitched  
Edging



Hushh  
Acoustic  
Sound  
Absorption  
Panels



Group 2 Fabric: Velito Presto (see page 122) and Camira Synergy (see page 125).

Not available in Camira Lucia fabric.

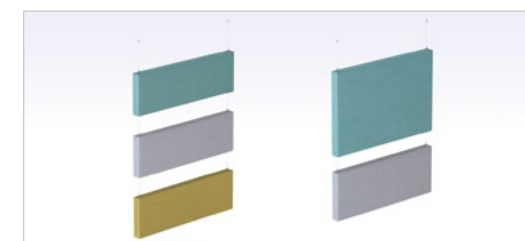

## FABRIC DESKTOP SCREENS

PVC Edged Fabric Desk Screen with radius corners

Code	Size (mm)	Group 1 Price (\$)	Group 2 Price (\$)
PV/785-380/ST	w785 h380	101	118
PV/800-380/ST	w800 h380	101	118
PV/1200-380/ST	w1200 h380	120	144
PV/1400-380/ST	w1400 h380	126	153
PV/1600-380/ST	w1600 h380	149	180
PV/1800-380/ST	w1800 h380	156	191

25mm Thick Fabric Desk Screen, radiused corners

Code	Size (mm)	Group 1 Price (\$)	Group 2 Price (\$)
FR/705-385/ST	w705 h380	145	171
FR/785-380/ST	w785 h380	134	155
FR/800-380/ST	w800 h380	134	155
FR/1200-380/ST	w1200 h380	160	191
FR/1400-380/ST	w1400 h380	168	204
FR/1600-380/ST	w1600 h380	194	236
FR/1800-380/ST	w1800 h380	196	237

25mm Thick Fabric Desk Screen, Blazer Life Fabric

Code	Size (mm)	Price (\$)
FS/800-380/ST	w800 h380	254
FS/1200-380/ST	w1200 h380	262
FS/1400-380/ST	w1400 h380	275
FS/1600-380/ST	w1600 h380	311
FS/1800-380/ST	w1800 h380	447

40mm thick acoustic wall or hanging ceiling panels

Code	Size (mm)	Group 2 Price (\$)
APU040	w400 h400 d40	73
APU041	w400 h800 d40	112
APU042	w400 h1200 d40	154
APU043	w800 h800 d40	232
APU044	w800 h1200 d40	270
APU045	w1200 h1200 d40	494

70mm thick acoustic wall or hanging ceiling panels

Code	Size (mm)	Group 2 Price (\$)
APU070	w400 h400 d70	97
APU071	w400 h800 d70	143
APU072	w400 h1200 d70	197
APU073	w800 h800 d70	301
APU074	w800 h1200 d70	355
APU075	w1200 h1200 d70	645

Accessories for fixing and hanging

Code	Length (mm)	Description	Price (\$)
APU050	50 - 1200	Suspension cable kit	42
APU051	50 - 3000	Suspension cable kit	73
APU047		Wall fixings HD	31
APU048		Wall fixings LD	31
APU049		Panel connectors 2 pcs	15

Double sided vertically suspended acoustic panels

Code	Size (mm)	Group 2 Price (\$)
APU046	w1200 h400 d46	197
APU082	w1200 h800 d46	355

Suspension cable kits  
Price (\$)

APU076	50 - 1200mm Starter	19
APU077	50 - 1200mm Inter-connector	15
APU078	50 - 3000mm Extra Long Starter	35

## HUSHH ACOUSTIC DESK SCREENS & MODESTY PANELS

Acoustic screens for stand alone height adjustable and back to back VERSA desks.

Our acoustic screens are filled with noise reducing material and covered in felt wool or polyester fabric. They deliver improved visual and audio protection, providing more privacy without isolating employees from each other.



### IMPORTANT NOTES: ACOUSTIC FABRIC SCREENS

Group 1 Fabric Camira Lucia (See available fabric colours on page 122).  
Group 2 Fabric Camira Synergy (See available fabric colours on page 125),  
Velito Presto (See available fabric colours on page 122).

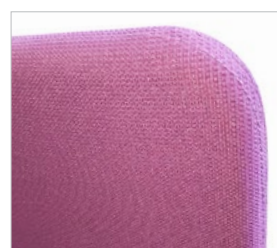

Hushh  
Acoustic  
Fabric Edged  
Screen

\*530mm height above  
desktop



#### Side acoustic screen for stand alone desk

Code	Size (mm)	Group 1 Price (\$)	Group 2 Price (\$)
ATK070	w700 d36 h595*	89	112
ATK080	w800 d36 h595*	104	131



#### Acoustic screen for stand alone desk

Code	Size (mm)	Group 1 Price (\$)	Group 2 Price (\$)
ATP120	w1200 d36 h595*	151	205
ATP140	w1400 d36 h595*	181	216
ATP160	w1600 d36 h595*	205	224
ATP180	w1800 d36 h595*	270	274



#### Acoustic screen for benches

Code	Size (mm)	Group 1 Price (\$)	Group 2 Price (\$)
ATV120	w1200 d36 h555*	178	201
ATV140	w1400 d36 h555*	181	208
ATV160	w1600 d36 h555*	205	212
ATV180	w1800 d36 h555*	239	270
G4F021	(Brackets for sliding bench)		12

Hushh Set of  
2 Acoustic  
Screens for  
Benches



#### Set of 2 acoustic screens for benches

Code	Size (mm)	Group 1 Price (\$)	Group 2 Price (\$)
ATS070	w710 d36 h530*	239	270
ATS080	w810 d36 h530*	247	324

## HUSHH ACOUSTIC DESK SCREENS & MODESTY PANELS

Hushh  
Acoustic Floor  
Standing  
Screen



#### Acoustic floor-standing screen for desk end

Code	Size (mm)	Side	Group 1 Price (\$)	Group 2 Price (\$)
ATL100	w1000 d36 h1270*	Left	313	355
ATR100	w1000 d36 h1270*	Right	313	355

Acoustic  
Fabric Edged  
Screen  
for Height  
Adjustable  
Desk

\*0 - 500mm screen height  
above the desktop



#### Acoustic screen for height adjustable desk

Code	Size (mm)	Group 1 Price (\$)	Group 2 Price (\$)
ATP122	w1200 d36 h595*	185	236
ATP142	w1400 d36 h595*	208	247
ATP162	w1600 d36 h595*	212	251
ATP182	w1800 d36 h595*	297	305

### 760mm High Desk Screen

Hushh Side  
Acoustic  
Fabric Edged  
Screen



#### Side acoustic screen for stand alone desk

Code	Size (mm)	Group 1 Price (\$)	Group 2 Price (\$)
ADK100	w1000 d36 h760* Left	168	222
ADK101	w1000 d36 h760* Right	168	222

Hushh  
Acoustic  
Fabric Edged  
Screen

\*530mm screen height  
above the desktop



#### Acoustic screen for 1400mm desk

Code	Size (mm)	Group 1 Price (\$)	Group 2 Price (\$)
ADP140	w1400 d36 d760*	237	258



#### Acoustic screen for 1600mm desk

Code	Size (mm)	Group 1 Price (\$)	Group 2 Price (\$)
ADP160	w1600 d36 d760*	244	271



## HUSHH FREE STANDING ACOUSTIC SCREENS

### Free Standing Screens

Group 1 Fabric: Camira Lucia (see page 122).

Group 2 Fabric: Velito Presto (see page 122) and Camira Synergy (see page 125).



#### 800mm wide, free standing acoustic screen

Code	Dimensions	Group 1 Price (€)	Group 2 Price (€)
AFU083	w800 d36 h1200	206	266
AFU080	w800 d36 h1400	233	274
AFU081	w800 d36 h1600	245	286
AFU082	w800 d36 h1800	371	537



#### 1000mm wide, free standing acoustic screen

Code	Dimensions	Group 1 Price (€)	Group 2 Price (€)
AFU100	w1000 d36 h1200	283	344
AFU101	w1000 d36 h1400	290	347
AFU102	w1000 d36 h1600	294	355
AFU103	w1000 d36 h1800	401	514



#### 1200mm wide, free standing acoustic screen

Code	Dimensions	Group 1 Price (€)	Group 2 Price (€)
AFU120	w1200 d36 h1200	336	402
AFU121	w1200 d36 h1400	344	409
AFU122	w1200 d36 h1600	351	413
AFU123	w1200 d36 h1800	432	537



#### 1400mm wide, free standing acoustic screen

Code	Dimensions	Group 1 Price (€)	Group 2 Price (€)
AFU140	w1400 d36 h1200	355	405
AFU141	w1400 d36 h1400	401	467
AFU142	w1400 d36 h1600	424	475
AFU143	w1400 d36 h1800	462	560

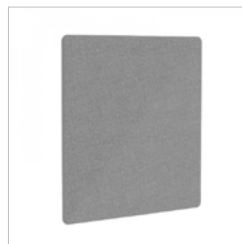

#### 1600mm wide, free standing acoustic screen

Code	Description	Group 1 Price (€)	Group 2 Price (€)
AFU160	w1600 d36 h1200	363	409
AFU161	w1600 d36 h1400	424	475
AFU162	w1600 d36 h1600	489	537
AFU163	w1600 d36 h1800	489	583



## HUSHH FREE STANDING ACOUSTIC SCREENS

### Free Standing Screen Connectors



Connects two screens inline (2 pcs.)

Code	AFZ001
Size (mm)	w112 d34 h8
Price (€)	15



Connects two screens at a right angle (2 pcs.)

Code	AFZ002
Size (mm)	w86 d60 h8
Price (€)	15

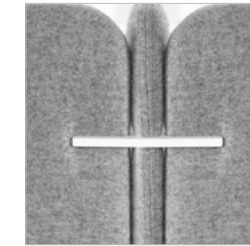

Connects three screens, one at a right angle (2 pcs.)

Code	AFZ003
Size (mm)	w138 d60 h8
Price (€)	23

### Free Standing Screen Feet



Set of metal legs (4 pcs.)

Code	AFZ040
Size (mm)	w400
Price (€)	84



Set of metal feet on castors (4 pcs.)

Code	AFZ041
Size (mm)	w400
Price (€)	141



## HUSHH MEETING POD

Create a silent zone in your work environment for meetings, ideas, individual work or just for recreation.

The pod consists of acoustic walls, filled with sound-absorbing materials and two poufs (left and right) with brackets.

A convenient workspace with great sound isolation for meetings or presentations.



### Meeting Pod

Supplied in Velito Presto fabric (see page 122) or Camira Synergy fabric (see page 125)



Upholstered acoustic walls of "meeting pod" with black MDF feet

Code	Size (mm)	Price (€)
AGS180	w1810 d925 h1420	1623

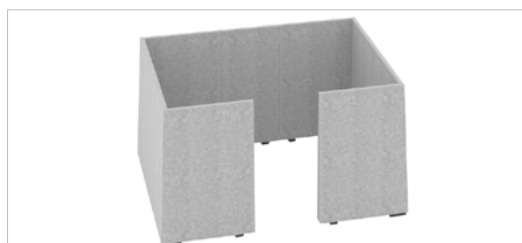

Upholstered acoustic walls of "meeting pod" with black MDF feet

Code	Size (mm)	Price (€)
AGS181	w1810 d2500 h1420	3587



Upholstered acoustic walls of "meeting pod" with desk (1200x650 h663) and black MDF feet

Code	Size (mm)	Price (€)
AGS182	w1810 d2500 h1420	3713



Upholstered acoustic walls of "meeting pod" with desk (1200x650 h663), monitor holder, power socket, wires box and black MDF feet

Code	Size (mm)	Price (€)
AGS183	w1810 d2500 h1420	3861

### Poufs

Supplied in Velito Presto fabric (see page 122)



### Extras



## HUSHH MEETING POD

Left hand pouf for "meeting pod" with linking parts. Base - black painted metal

Code	Size (mm)	Side	Price (€)
SGA1L0	w800 d600 h400	Left	486

Right hand pouf for "meeting pod" with linking parts. Base - black painted metal

Code	Size (mm)	Side	Price (€)
SGA1R0	w800 d600 h400	Right	486

Left hand pouf for "meeting pod" with power socket and linking parts. Base - black painted metal

Code	Size (mm)	Side	Price (€)
SGA109	w800 d600 h400	Left	581

Right hand pouf for "meeting pod" with power socket and linking parts. Base - black painted metal

Code	Size (mm)	Side	Price (€)
SGA110	w800 d600 h400	Right	581

Back cushion

Code	Size (mm)	Price (€)
ZGZ005	w800 d200 h300	148

Metal table for pouf

Code	Size (mm)	Price (€)
SGZ001	w602 d400 h122	114

Clip on "Do not disturb man" for screens

Code	Size (mm)	Price (€)
ATS070	w118 d44 h121	42



## OSLO MESH BACK OPERATOR CHAIR

Functional operator chair with unbeatable value.

With its mesh back and rear chrome accent, its stylish integrated armrests and its lockable tilting mechanism, our OSLO chair cuts a path of value, aesthetics and features rarely ever seen at a similar price point.

Available in all black only.

COMING Q3 2019



Oslo Operator Chair with Black Fabric Seat, Black Mesh Back and Lockable Tilt Mechanism

Code	Description	Price (€)
CHO2001	All black mesh/fabric/plastic	159



## VIENNA PREMIER MESH BACK TASK CHAIR

Amazing value, fully loaded.

Our latest task chair comes fully loaded and full of value, featuring a self-balance mechanism, a moulded foam sliding seat, padded arm rests, adjustable headrest, polished aluminium base and gas lift.

Stocked in black fabric.



Vienna Premier Task Chair with Self-Balance Mech, Sliding Seat, Padded Arm Rests, Head Rest and Mesh Back

Code	Base/Gas Lift Finish	Price (€)
CHT5001	Polished Aluminium	299



## VIENNA MESH BACK TASK CHAIR

Strength, comfort, style and performance at a value price.

Our latest task chair featuring a synchro mech, fixed black fabric seat, black nylon base.

Stocked in black fabric.

COMING Q3 2019



Vienna Task Chair with Synchro Mech, Fixed Seat and Black Nylon Base

Code	Base/Gas Lift Finish	Price (€)
CHT4001	Black plastic	209
CHT-ARMS	Optional armrests	25



## LONDON MESH BACK TASK CHAIR

Assembled in-house and made using only the best components.

The London chair includes features such as height adjustable lumbar support as standard and a breathable mesh back making it comfortable all year round.

Camira Xtreme (p123)  
See page 91 for arm rest options



London Task Chair with 5 Position Synchro Mech, Tension Adjustment, Fixed Fabric Seat and Standard Mesh Back

Code	Base/Gas	Price (€)
LON000	Black Nylon	277
LON001	Aluminium	319

London Task Chair with Self-Balance Mech, Fixed Fabric Seat and Standard Mesh Back

Code	Base/Gas	Price (€)
LON100	Black Nylon	284
LON101	Aluminium	326

Headrest for LONDON Chair

Code	Price (€)
LONDHR	30



\*Optional armrests shown in some illustrations.

## PRAGUE MESH BACK TASK CHAIR

Elegantly designed to perfectly integrate into modern office environments.

Prague allows the user to retain energy throughout long hours of computer use. The flexible support of the breathable mesh backrest prevents discomfort when combined with this chair's many adjustments.

Available in Camira Xtreme fabric (Group 1), Velito (G2) and Camira Synergy (G2).



### Prague Mesh Back Task Chair

Code	Description	G1 Price (€)	G2 Price (€)
SIC620	Task Chair, White Body, Black Gas Lift and Base, Synchro Mechanism with Tension Adjustment	320	335
SIC720	Task Chair, White Body with Lumbar Support, Black Gas Lift and Base, Synchro Mechanism with Tension Adjustment	327	342
SIC820	Task Chair, White Body, Polished Alu Gas Lift and Base, Synchro Mechanism with Tension Adjustment	365	376
SIC920	Task Chair, White Body with Lumbar Support, Polished Alu Gas Lift and Base, Synchro Mechanism with Tension Adjustment	372	387
SIC220	Task Chair, Black Body, Black Gas Lift and Base, Synchro Mechanism with Tension Adjustment	293	316
SIC430	Task Chair, Black Body with Lumbar Support, Black Gas Lift and Base, Synchro Mechanism with Tension Adjustment	301	362
SIC530	Task Chair, Black Body, Polished Alu Gas Lift and Base, Synchro Mechanism with Tension Adjustment	346	354
SIC630	Task Chair, Black Body with Lumbar Support, Polished Alu Gas Lift and Base, Synchro Mechanism with Tension Adjustment	354	361
SIC030	Task Chair, White Body, Black Gas Lift and Base, Synchro Mechanism with Side Tension Adjustment	350	365
SIC130	Task Chair, White Body with Lumbar Support, Black Gas Lift and Base, Synchro Mechanism with Side Tension Adjustment	357	372
SIC230	Task Chair, White Body, Polished Alu Gas Lift and Base, Synchro Mechanism with Side Tension Adjustment	399	410
SIC330	Task Chair, White Body with Lumbar Support, Polished Alu Gas Lift and Base, Synchro Mechanism with Side Tension Adjustment	403	418
SIC520	Task Chair, Black Body, Black Gas Lift and Base, Synchro Mechanism with Side Tension Adjustment	327	346
SIC730	Task Chair, Black Body with Lumbar Support, Black Gas Lift and Base, Synchro Mechanism with Side Tension Adjustment	335	350
SIC830	Task Chair, Black Body, Polished Alu Gas Lift and Base, Synchro Mechanism with Side Tension Adjustment	384	391
SIC930	Task Chair, Black Body with Lumbar Support, Polished Alu Gas Lift and Base, Synchro Mechanism with Side Tension Adjustment	391	399



Fixed armrests (2pcs.)	Fixed plastic armrests (2pcs.)	Height adjustable armrests in black or white (2pcs.)	2D adjustable armrests with soft PU pads (2pcs.)	Headrest for Prague mesh back task chair
Code: SZZ000-A Size (mm): w165 d230 h275	Code: SZZ008-A Size (mm): w190 d300 h250	Code: SZZ100-A & SZZ100-E Size (mm): w200 d248 h250-320	Code: SZZ101-A Size (mm): w160 d230 h300-395	Code: PNA00751
Price (€): 19	Price (€): 34	Black (SZZ100-A) (€): 34 White (SZZ100-E) (€): 45	Price (€): 68	Price (€): 45

## MADRID TASK CHAIR

Superior quality office chair with a wide choice of comfort options.

When you sit properly, work efficiency is improved as the relaxed mind works better and stress levels reduce. This is a chair designed with particular attention to correct posture. High quality height adjustable mesh back, thickly padded upholstered seat. Options include seat depth slide adjustment, lumbar support, polished aluminium base and upholstered headrest.

Available in Camira Xtreme fabric (p123). See below for arm rest options.



Height adjustable armrests, plastic pads	Height adjustable armrests, PU pads	2D adjustable armrests, PU pads	3D adjustable armrests, PU pads
Code: AR1DPP Price (€): 25	Code: AR1DPU Price (€): 40	Code: AR2DPU Price (€): 50	Code: AR3DPU Price (€): 60



3D adjustable armrests, plastic pads, aluminium	Width adjustment system to change 3D to 4D
Code: AR3DPU-AL Price (€): 95	Code: AR4DWA Price (€): 20



### Madrid Chair with 5 Position Synchro Mech, Fixed Moulded Foam Seat and Height Adjustable Ratchet Back

Code	Description	Price (€)
MAD000	Black Nylon Base	387
MAD001	Aluminium Base	429

### Madrid Chair with Self Balance Mech, Fixed Moulded Foam Seat and Height Adjustable Ratchet Back with Lumbar Support

Code	Description	Price (€)
MAD100	Black Nylon Base	428
MAD101	Aluminium Base	471

### Madrid Chair with Self Balance Mech, Sliding Moulded Foam Seat and Height Adjustable Ratchet Back with Lumbar Support

Code	Description	Price (€)
MAD102	Black Nylon Base	452
MAD103	Aluminium Base	494
MADRHR	Fully adjustable headrest	66



## OSLO CANTILEVER BASE MEETING CHAIR

Strength, comfort, style and performance at a value price.

Working in tandem with its task chair equivalent, the OSLO cantilever base meeting chair sports the same sleek black outfit with integrated armrests and an all black metal cantilever base.

Available in all black only.



Oslo Cantilever Base Meeting Chair with Black Fabric Seat and Black Mesh Back

Code	Description	Price (€)
CHC2001	All black mesh/fabric/plastic/metal	155

## MADRID MEETING CHAIR

Smart visitor or meeting chair to complement the Madrid premium office chair.

Stylish and comfortable mesh back in black frame on chrome cantilever base. Built in arm design which finishes with a unique polished chrome bolt through detail on the fixing to the back.

Available in any Camira Xtreme fabric (G1) or Camira Synergy/Velito (G2).



Madrid Meeting Chair

Code	Description	Group 1 Price (€)	Group 2 Price (€)
SIA524	Black mesh back and frame cantilever	320	324
SIA514	Black mesh back and frame 4 legs	320	324



SIA524

SIA514

SIA524

## PRAGUE MEETING CHAIR

Grace and strength characterises the Prague chair.

Comfortable and stylish mesh back available with a choice of black or white frame, optional black or polished aluminium armrests, fixed to the attractive chrome cantilever frame. Matches Prague task chair.

Available in Camira Xtreme (G1) or Camira Synergy/Velito fabric (G2) with a choice of black or white mesh back.



Prague Meeting Chair

Code	Description	Group 1 Price (€)	Group 2 Price (€)
SUA020	Black back frame, cantilever leg	211	226
SUA120	White back frame, cantilever leg	233	241
SUA224	Black back frame, cantilever leg with integral armrests	275	282
SUA324	White back frame, cantilever leg with integral armrests	293	305



SZZ007-A Black armrests 35



SUA324

SUA120 SZZ007-A

SUA020

## ATLANTA MEETING CHAIR

Economical and popular style of meeting chair with a choice of back styles and sizes.

Choose from mesh or upholstered fabric back styles. Fabric back style available in small or full back options. Cantilever or 4 leg base styles with integral arm rest available in silver, black or chrome at the same price. Stackable up to 6 high.

Available in any Camira Xtreme fabric (G1) or Camira Synergy/Velito (G2)



Prague Meeting Chair

Code	Description	Group 1 Price (€)	Group 2 Price (€)
SIA104	Black mesh back 4 leg	203	218
SIA124	Black mesh back cantilever	203	218
SIA004	Small upholstered back 4 leg	203	218
SIA024	Small upholstered back cantilever	203	218
SIA224	Full upholstered back cantilever	233	275



SIA224

SIA024

SIA124



SIA104



SIA004



## STOCKHOLM MEETING CHAIR

Stockholm is a compelling executive chair combining gentle curves and slim edge details.

A chair with unique elegance and style. The optional fully upholstered armrests are an integral part of the seat structure. Optional additional seat cushion fits all styles.

Group 1 = Camira Xtreme (p123)  
Group 2 = Camira Synergy/Velito (p124/125)



### Geneva Reception Chair

Code	Description	Group 1 Price (€)	Group 2 Price (€)
SNA400	Med back 4 leg base chrome finish	319	334
SNA600	Med back cantilever base chrome finish	346	372
SNA210	Med back swivel 4 leg alum base blk/polished	513	547
SPA017	Smooth fabric design	448	521
SNA010	Hi back swivel 4 leg alum base blk/polished	654	695
SNA013	Hi back armchair 4 leg alum base blk/polished	878	897
SNZ001	Additional seat cushion	34	53



## GENEVA RECEPTION CHAIR

Warm, welcoming, cosy curves. A spacious comfortable easy chair.

Ideal for customer waiting and staff breakout areas.

Choose from classic ribbed stitching or smooth fabric alongside the polished chrome frame. Geneva gives an instant uplift to any space.

Group 1 = Camira Xtreme (p123)  
Group 2 = Camira Synergy/Velito (p124/125)



### Geneva Reception Chair

Code	Description	Group 1 Price (€)	Group 2 Price (€)
SPA015	Classic ribbed stitching	414	490
SPA017	Smooth fabric design	448	521





## SEATTLE STACKABLE MEETING CHAIR

Neat lines, a light and slender silhouette.

The one piece wooden or upholstered seat and back of the Seattle is available with a choice of 2 leg styles. The chairs do not occupy a lot of space as they can be conveniently stacked up to 5 high. Seattle is a stylish affordable design ideal for cafe & breakout areas as well as all conference and meeting requirements.

Upholstered chairs are available in the following fabrics:

Group 1 = Camira Xtreme (p123)

Group 2 = Camira Synergy/Velito (p124/125)



### Seattle Conference Chair

Code	Description	Group 1 Price (€)	Group 2 Price (€)
SXA420	Chrome Plated Sled Base Meeting Chair, Upholstered Seat and Back	184	222
SXA020	Black or White Powder Coated Sled Base Meeting Chair, Upholstered Seat and Back	196	248
SXA000	Chrome Plated Four Leg Meeting Chair, Upholstered Seat and Back	203	252
SXA004	Chrome Plated Four Leg Meeting Chair with Integral Arms, Upholstered Seat and Back	263	316
SXA520	Black or White Powder Coated Sled Base Meeting Chair, Veneer Seat and Back	150	181
SXA120	Chrome Plated Sled Base Meeting Chair, Veneer Seat and Back	158	184
SXA100	Chrome Plated Four Leg Meeting Chair, Veneer Seat and Back	166	188
SXA104	Chrome Plated Four Leg Meeting Chair with Integral Arms, Veneer Seat and Back	226	248
SXA200	Chrome Plated Four Leg High Stool, Upholstered Seat and Low Back	207	233
SXA500	Chrome Plated Sled Base High Stool, Veneer Seat and Low Back	241	263
SXA600	Black or White Powder Coated Sled Base High Stool, Veneer Seat and Low Back	214	237



Group 1 beech veneer (Z1).

Group 2 oak veneer (Z2), white laminate (Z3) and beech stained black veneer (Z4).

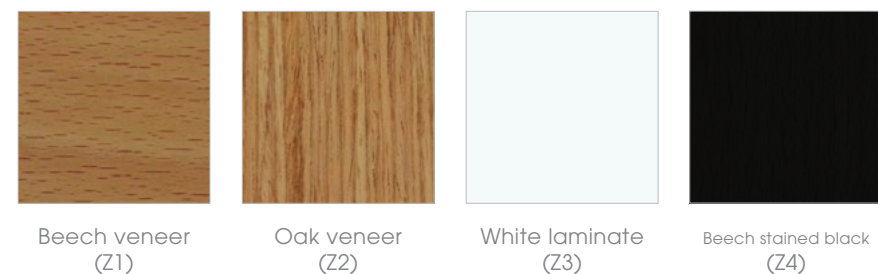

## NEW YORK STACKING CHAIR

A modern light airy design, this versatile chair range looks at home everywhere.

Educational institutes, conference halls, visitor lounges, dining halls and more. Available in four leg and Sled base styles as well as a high bar stool design. 7 plastic colours and optional upholstered seat and back pads. 4 leg style stacks to 6 high and sled base to 10 high or 16 and 21 respectively on optional trolley. Options include linking clips for conference halls, arm rest style frame, folding tablet (only for use on armchairs).

Upholstery available in Camira Xtreme fabric (p123)



### New York Stacking Chair

Code	Description	Price (€)
SUA000	4 Leg plastic seat/back	132
SUA001	4 Leg armchair plastic seat/back	184
SUA220	Sled base plastic seat/back	132
SUA300	Bar stool, plastic seat/back	207
SUA100	4 Leg upholstered seat/plastic back	154
SUA101	4 Leg armchair upholstered seat/plastic back	211
SUA320	Sled base upholstered seat/plastic back	154
SUA400	Bar stool upholstered seat/plastic back	229
SUA200	4 Leg upholstered seat & back	181
SUA201	4 Leg armchair upholstered seat & back	233
SUA420	Sled base upholstered seat & back	181
ZUZ001	Trolley for high stacking and transport	275
ZUZ002	RH folding table (for use on armchairs only)	68
ZUZ003	Linking glides (sled base only)	8

### Plastic Colour Options

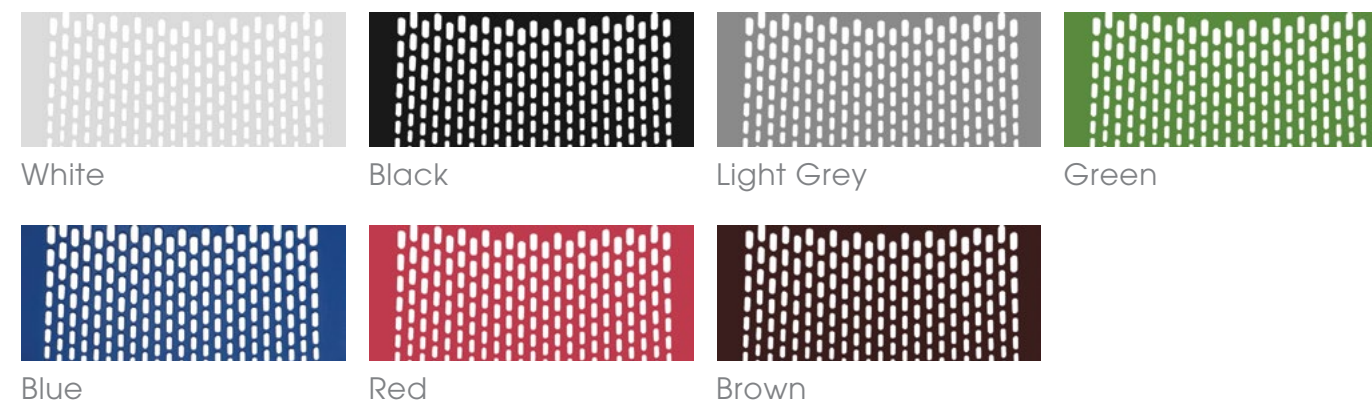

# VALENCIA LOUNGE SEATING

Create modern and functional office or public spaces with Valencia.

3 different height levels and infinite combinations. The high-back option provides greater privacy and acoustic protection.

Group 1 (G1) pricing = Berta fabric (see page 125)  
Group 2 (G2) pricing = Camira Synergy fabric (see page 125)



## Poufs



1 Seater Pouf      2 Seater Pouf      3 Seater Pouf      1 Seater Curved Pouf

Watch the Valencia video on youtube.com by scanning the QR code below:



Or visit [goo.gl/VuVYVT](http://goo.gl/VuVYVT) to watch the video now.

Code	SHA100	Code	SHA200	Code	SHA300	Code	SHA101
Size (mm)	w640 d640 sh420	Size (mm)	w1280 d640 sh420	Size (mm)	w1920 d425 sh420	Size (mm)	w1020 d710 sh420
Metal Legs G1	£ 313	Metal Legs G1	£ 526	Metal Legs G1	£ 738	Metal Legs G1	£ 432
Metal Legs G2	£ 374	Metal Legs G2	£ 630	Metal Legs G2	£ 871	Metal Legs G2	£ 515
Wooden Legs G1	£ 389	Wooden Legs G1	£ 601	Wooden Legs G1	£ 814	Wooden Legs G1	£ 508
Wooden Legs G2	£ 450	Wooden Legs G2	£ 706	Wooden Legs G2	£ 947	Wooden Legs G2	£ 590



4 Seater Curved Pouf

Code	SHA400
Size(mm)	w2680 d1340 sh420
Metal Legs G1	£ 1742
Metal Legs G2	£ 2030
Wooden Legs G1	£ 1930
Wooden Legs G2	£ 2218

## Sofas



1 Seater Sofa      2 Seater Sofa      3 Seater Sofa      4 Seater Sofa

Code	SHA102	Code	SHA201	Code	SHA301	Code	SHA401
Size (mm)	w730 d705 h830	Size (mm)	w1370 d705 h830	Size (mm)	w2010 d705 h830	Size (mm)	w2650 d705 h830
Metal Legs G1	£ 1030	Metal Legs G1	£ 1523	Metal Legs G1	£ 1940	Metal Legs G1	£ 2851
Metal Legs G2	£ 1213	Metal Legs G2	£ 1807	Metal Legs G2	£ 2315	Metal Legs G2	£ 3359
Wooden Legs G1	£ 1105	Wooden Legs G1	£ 1598	Wooden Legs G1	£ 2016	Wooden Legs G1	£ 3002
Wooden Legs G2	£ 1289	Wooden Legs G2	£ 1883	Wooden Legs G2	£ 2390	Wooden Legs G2	£ 3510

# VALENCIA LOUNGE SEATING

## Sofas



5 Seater Sofa      4 Seater Curved Sofa      10 Seater Curved Sofa

Code	SHA500	Code	SHA402	Code	SHA010
Size (mm)	w3290 d705 h830	Size (mm)	w1370 d705 h830	Size (mm)	w2810 d3370 h830
Metal Legs G1	£ 3265	Metal Legs G1	£ 4118	Metal Legs G1	£ 7783
Metal Legs G2	£ 3859	Metal Legs G2	£ 4921	Metal Legs G2	£ 9241
Wooden Legs G1	£ 3416	Wooden Legs G1	£ 4306	Wooden Legs G1	£ 8122
Wooden Legs G2	£ 4010	Wooden Legs G2	£ 5108	Wooden Legs G2	£ 9580

## Highback Sofas



1 Seater Highback Sofa      2 Seater Highback Sofa      3 Seater Highback Sofa      4 Seater Highback Sofa

Code	SHA103	Code	SHA203	Code	SHA302	Code	SHA403
Size(mm)	w800 d815 h1380	Size(mm)	w1440 d815 h1380	Size(mm)	w2080 d815 h1380	Size (mm)	w2720 d815 h1380
Metal Legs G1	£ 1721	Metal Legs G1	£ 2362	Metal Legs G1	£ 2909	Metal Legs G1	£ 4180
Metal Legs G2	£ 1987	Metal Legs G2	£ 2754	Metal Legs G2	£ 3420	Metal Legs G2	£ 4864
Wooden Legs G1	£ 1796	Wooden Legs G1	£ 2437	Wooden Legs G1	£ 2984	Wooden Legs G1	£ 4331
Wooden Legs G2	£ 2063	Wooden Legs G2	£ 2830	Wooden Legs G2	£ 3496	Wooden Legs G2	£ 5015



5 Seater Highback Sofa      4 Seater Highback Curved Sofa      10 Seater Highback Curved Sofa

Code	SHA501	Code	SHA404	Code	SHA011
Size(mm)	w3360 d815 h1380	Size(mm)	w3030 d1595 h1380	Size (mm)	w3030 d3515 h1380
Metal Legs G1	£ 4723	Metal Legs G1	£ 6124	Metal Legs G1	£ 10948
Metal Legs G2	£ 5530	Metal Legs G2	£ 7218	Metal Legs G2	£ 12863
Wooden Legs G1	£ 4874	Wooden Legs G1	£ 6311	Wooden Legs G1	£ 11286
Wooden Legs G2	£ 5681	Wooden Legs G2	£ 7405	Wooden Legs G2	£ 13201



Connecting brackets for combinations (2 pcs.)      Set of legs (2 pcs.). Must be ordered to complete the combination

Code	SHZ001	Code	SHZ003
Size(mm)	w800 d815 h830		
Metal	£ 29	Metal Legs	£ 14
		Wooden Legs	£ 50



## VALENCIA LOUNGE SEATING

Seat  
Segments

1 seater segment with 2 legs

**Code** SHA104  
**Size (mm)** w640 d640 sh420

Metal Legs G1 £ 302  
Metal Legs G2 £ 364  
Wooden Legs G1 £ 338  
Wooden Legs G2 £ 400



2 seater segment with 2 legs

**Code** SHA204  
**Size (mm)** w1280 d640 sh420

Metal Legs G1 £ 515  
Metal Legs G2 £ 619  
Wooden Legs G1 £ 551  
Wooden Legs G2 £ 655



3 seater segment with 2 legs

**Code** SHA303  
**Size (mm)** w1920 d640 sh420

Metal Legs G1 £ 727  
Metal Legs G2 £ 860  
Wooden Legs G1 £ 763  
Wooden Legs G2 £ 896



1 seater curved segment with 2 legs

**Code** SHA105  
**Size (mm)** w1020 d710 sh420

Metal Legs G1 £ 421  
Metal Legs G2 £ 504  
Wooden Legs G1 £ 457  
Wooden Legs G2 £ 540

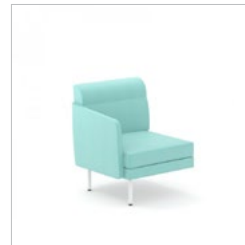

Right side 1 seater segment with 2 legs

**Code** SHA1R0  
**Size (mm)** w685 d705 h830

Metal Legs G1 £ 839  
Metal Legs G2 £ 994  
Wooden Legs G1 £ 875  
Wooden Legs G2 £ 1030

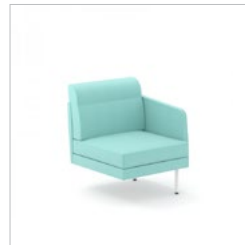

Left side 1 seater segment with 2 legs

**Code** SHA1L0  
**Size (mm)** w685 d705 h830

Metal Legs G1 £ 839  
Metal Legs G2 £ 994  
Wooden Legs G1 £ 875  
Wooden Legs G2 £ 1030

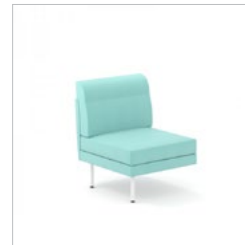

Middle 1 seater segment with 2 legs

**Code** SHA1M0  
**Size (mm)** w640 d705 h830

Metal Legs G1 £ 644  
Metal Legs G2 £ 774  
Wooden Legs G1 £ 680  
Wooden Legs G2 £ 810



Middle 2 seater segment with 2 legs

**Code** SHA2M0  
**Size (mm)** w1280 d705 h830

Metal Legs G1 £ 1141  
Metal Legs G2 £ 1368  
Wooden Legs G1 £ 1177  
Wooden Legs G2 £ 1404



Middle 3 seater segment with 2 legs

**Code** SHA3M0  
**Size (mm)** w1920 d705 h830

Metal Legs G1 £ 1555  
Metal Legs G2 £ 1868  
Wooden Legs G1 £ 1591  
Wooden Legs G2 £ 1904

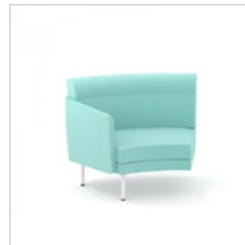

Right side curved 1 seater segment with 2 legs

**Code** SHA1R1  
**Size (mm)** w1080 d760 h830

Metal Legs G1 £ 1120  
Metal Legs G2 £ 1339  
Wooden Legs G1 £ 1156  
Wooden Legs G2 £ 1375

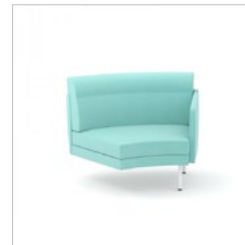

Left side curved 1 seater segment with 2 legs

**Code** SHA1L1  
**Size (mm)** w1080 d760 h830

Metal Legs G1 £ 1120  
Metal Legs G2 £ 1339  
Wooden Legs G1 £ 1156  
Wooden Legs G2 £ 1375

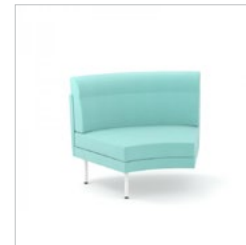

Middle curved 1 seater segment with 2 legs

**Code** SHA1M1  
**Size (mm)** w1080 d705 h830

Metal Legs G1 £ 925  
Metal Legs G2 £ 1120  
Wooden Legs G1 £ 961  
Wooden Legs G2 £ 1156



Highback right side 1 seater segment with 2 legs

**Code** SHA1R2  
**Size (mm)** w720 d815 h1380

Metal Legs G1 £ 1318  
Metal Legs G2 £ 1555  
Wooden Legs G1 £ 1354  
Wooden Legs G2 £ 1591



Highback left side 1 seater segment with 2 legs

**Code** SHA1L2  
**Size (mm)** w720 d815 h1380

Metal Legs G1 £ 1318  
Metal Legs G2 £ 1555  
Wooden Legs G1 £ 1354  
Wooden Legs G2 £ 1591



Highback middle 1 seater segment with 2 legs

**Code** SHA1M2  
**Size (mm)** w640 d815 h1380

Metal Legs G1 £ 893  
Metal Legs G2 £ 1051  
Wooden Legs G1 £ 929  
Wooden Legs G2 £ 1087



Highback middle two seater segment with 2 legs

**Code** SHA2M1  
**Size (mm)** w1280 d815 h1380

Metal Legs G1 £ 1530  
Metal Legs G2 £ 1822  
Wooden Legs G1 £ 1566  
Wooden Legs G2 £ 1858

Highback  
Seat Segments

## VALENCIA LOUNGE SEATING

Highback  
Seat Segments

Highback middle 3 seater segment with 2 legs

**Code** SHA3M1  
**Size (mm)** w1920 d815 h1380

Metal Legs G1 £ 2074  
Metal Legs G2 £ 2488  
Wooden Legs G1 £ 2110  
Wooden Legs G2 £ 2524



Highback RHS curved 2 seater segment with 2 legs

**Code** SHA1R3  
**Size (mm)** w1160 d875 h1380

Metal Legs G1 £ 1760  
Metal Legs G2 £ 2099  
Wooden Legs G1 £ 1796  
Wooden Legs G2 £ 2135



Highback LHS curved two seater segment with 2 legs

**Code** SHA1L3  
**Size (mm)** w1160 d875 h1380

Metal Legs G1 £ 1760  
Metal Legs G2 £ 2099  
Wooden Legs G1 £ 1796  
Wooden Legs G2 £ 2135



Highback middle two seater segment with 2 legs

**Code** SHA1M3  
**Size (mm)** w1140 d875 h1380

Metal Legs G1 £ 1332  
Metal Legs G2 £ 1580  
Wooden Legs G1 £ 1368  
Wooden Legs G2 £ 1616

## Extras

See page 106 for MFC and veneer finishes.

Veneer not available in cherry or mahogany.



Table (mounted between the settees; with connections)

**Code** SHD060  
**Size (mm)** w640 d640 h200

MFC £ 223  
Veneer £ 342



Table with 2 integrated UK power sockets (mounted between the settees; with connections)

**Code** SHD061  
**Size (mm)** w640 d640 h200

MFC £ 421  
Veneer £ 508



Upholstered armrest with two UK power sockets

**Code** SHZ002  
**Size (mm)** w185 d420 h210

G1 £ 389  
G2 £ 436



Mobile table with metal base

**Code** SHD041  
**Size (mm)** w400 d500 h620

MFC £ 241  
Veneer £ 259



# MONITOR ARMS



## KARDO High-spec monitor arm



- › Quick release VESA mounting plate
- › Installable in under 2 minutes **without the use of any tools**
- › One touch height adjustment
- › Complete cable management
- › Includes pre-assembled clamp and through desk fixing
- › Available in black, silver and white
- › Severe structural testing certified
- › Ergonomics and workstation posture certified



Certified to:  
BS EN ISO 9241 Workplace Ergonomics  
PP 045 Safety and Durability



Complete cable management



Clamp & through desk fixing



Quick release height adjustment

# MONITOR ARMS



## TWIN KARDO For dual screen display



- › Features 400mm high pole with dual multi-tilt arms
- › Takes two screens up to 27" or 20kg in total
- › Available in black, silver and white
- › Dual quick release 75mm VESA plates as standard

## QUAD KARDO For quad screen display

- › Features 700mm high pole with quad multi-tilt arms
- › Takes four screens up to 27" or 32kg in total
- › Available in black, silver and white
- › Quad quick release 75mm VESA plates as standard



Universal laptop holder attachment available

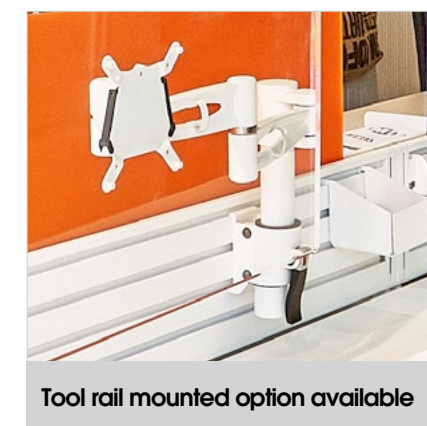

Tool rail mounted option available



Low profile mini clamp option available

CODE	DESCRIPTION	SCREEN WEIGHT CAPACITY	BLACK	SILVER	WHITE	RSP (\$)
PMA521	Pole Mounted Monitor Arm for single screen	12.5kg	•	•	•	£109.00
PMA522	Pole Mounted Monitor Arms for twin screens	2 x 10kg	•	•	•	£169.00
PMA524	Pole Mounted Monitor Arms for quad screens	4 x 8kg	•	•	•	£350.00
PMSA521	Tool Rail Mounted Pole Monitor Arm for single screen	6kg	•	•	•	£105.00
NBT101	Metalicon Laptop Holder attachment	10kg		•	•	£49.00
EP550	550mm high Kardo pole	N/A	•	•	•	£15.00
EP700	700mm high Kardo pole	N/A	•	•	•	£15.00
KMC1827	Kardo mini clamp	N/A	•	•	•	£9.00



# MONITOR ARMS

## LIBERO 2

### Slimline gas lift monitor arm

- › **NEW** (optional use) 180° rotation stop
- › **NEW** easy adjust head
- › **NEW** smoother gas lift

#### Also includes original Libero 1 features:

- › Clamp is tightened from above desk
- › Takes screens from 2-10kg
- › Complete cable management
- › Quick release VESA plate
- › Through desk option available
- › Available in black, silver and white
- › Severe structural testing certified
- › Ergonomics and workstation posture certified



**FIRA**  
 Certified to:  
 BS EN ISO 9241 Workplace Ergonomics  
 PP 045 Safety and Durability

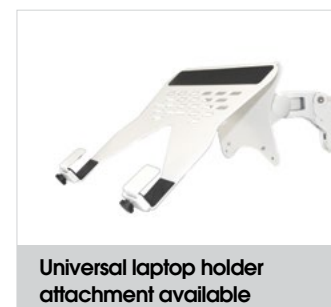
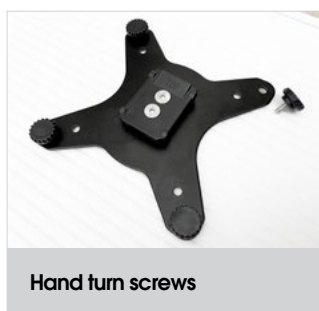
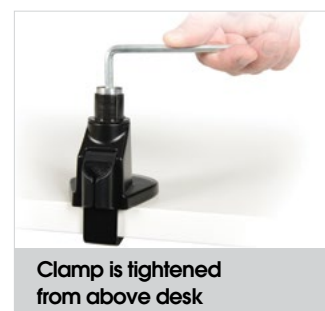
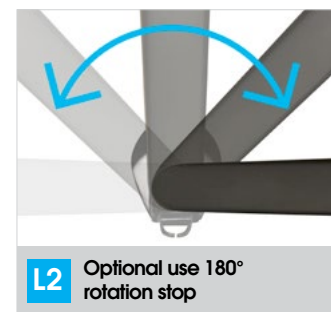

CODE	DESCRIPTION	BLACK	SILVER	WHITE	RSP (£)
GMA621	Libero Slimline Gas Lift Monitor Arm for single screen or twin rail up to 7kg	•	•	•	£199.00
GMA721	Libero 2 Slimline Gas Lift Monitor Arm for single screen or twin rail up to 10kg (8kg of screens)	•	•	•	£219.00
GMA6-TD	Through desk fixing kit for Libero Monitor Arm	•	•	•	£7.00
NBT101	Metalcon Laptop Holder attachment		•	•	£49.00

# MONITOR ARMS

## LIBERO TWIN RAIL

### For dual screen display

**FIRA**  
 Certified to:  
 BS EN ISO 9241 Workplace Ergonomics  
 PP 045 Safety and Durability



- › Supports 2 screens up to 4kg each in weight and 27" in size
- › Hinges allow individual monitor adjustment
- › Certified by FIRA as part of the Libero range

CODE	DESCRIPTION	BLACK	SILVER	WHITE	RSP (£)
TSMR-BK	Quick fit dual upgrade for Libero arm, capacity for two 4kg screens	•			£119.00

## THREE OR SIX SCREENS

### For the ultimate display

**FIRA**  
 Certified to:  
 BS EN ISO 9241 Workplace Ergonomics  
 PP 045 Safety and Durability

- › Supports up to six 10kg monitors up to 27" in screen size
- › Perfect for office, traders/brokers, gaming, multimedia and surveillance
- › 48mm pole and extra heavy duty hinged support arms
- › Removable VESA plates
- › Through-desk and desk edge clamp
- › Available in black only

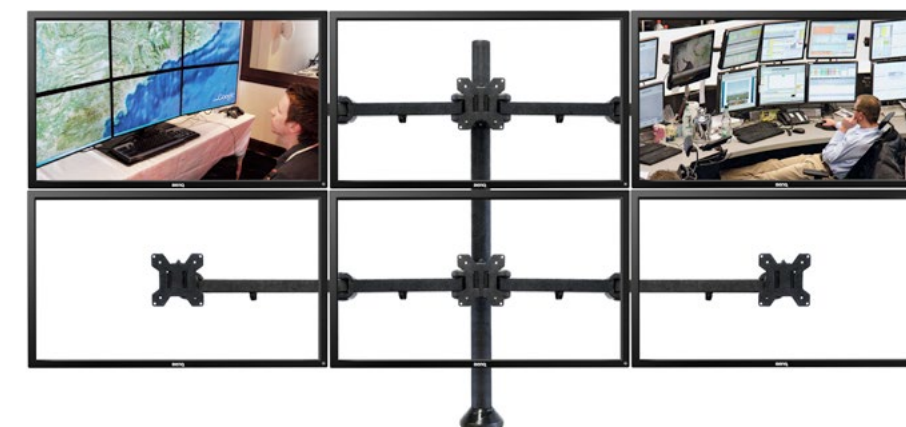

CODE	DESCRIPTION	BLACK	SILVER	WHITE	RSP (£)
PMA323	Three screen monitor arm	•			£298.00
PMA326	Six screen monitor arm	•			£498.00

## SINGLE SCREEN I-STAND

### Sit-stand workstation

Convert any standard desk in to a sit-stand desk. Metalicon i-stand allows the user to reap all the health and productivity gains of a sit-stand desk and monitor arm at a fraction of the price.

The i-stand units allow users to adjust the screen height and tilt totally separately to the keyboard height **without the use of any tools** – just instantly slide both parts up or down to find the best anthropometrics for your height and size. Essential for good posture and health.

- › Full tilt and swivel control.
- › Available in black and white.
- › Move screen and platform individually
- › No tools required to adjust

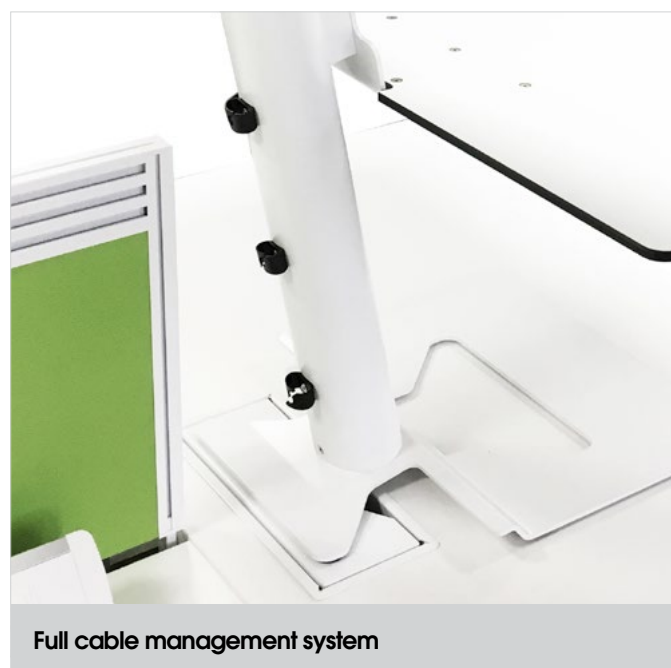
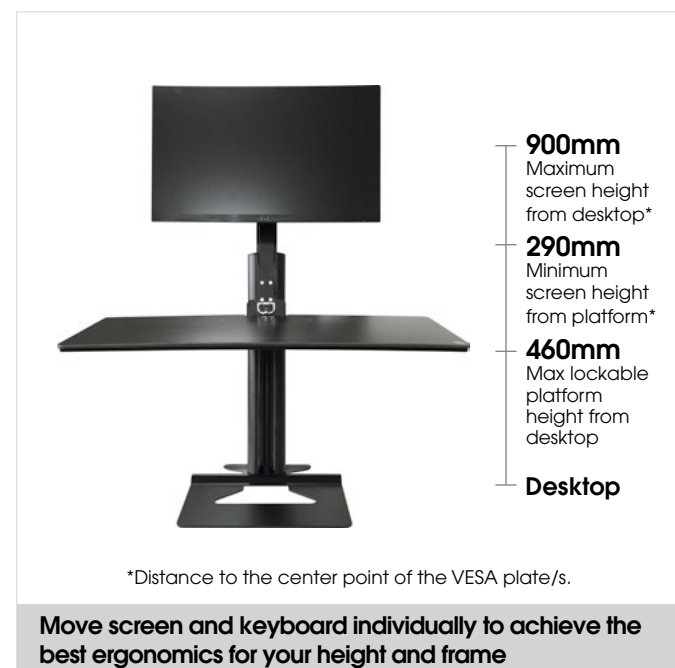

CODE	DESCRIPTION	ADJUSTABLE HEIGHT (mm)	MAX SCREEN WEIGHT (kg)	MAX PLATFORM WEIGHT (kg)	BLACK	WHITE	RSP (£)
SWD221	Metalicon i-stand single screen unit	15 - 460mm (max lockable platform height)	8.5kg	6kg	•	•	£679

## DUAL SCREEN I-STAND

### Dual screen sit-stand workstation

Achieve all the benefits of 'i-stand' with the productivity gains of using dual screens - in one easy to use package.

Studies indicate that dual screens can increase productivity by 20 – 50 percent, so when combined with all the benefits of a sit-stand desk, the user can convert their standard desk into a far superior working environment that will improve health, concentration and productivity.

- › Full tilt and swivel control.
- › Available in black and white.
- › Move screen and platform individually
- › No tools required to adjust
- › Dual screen display

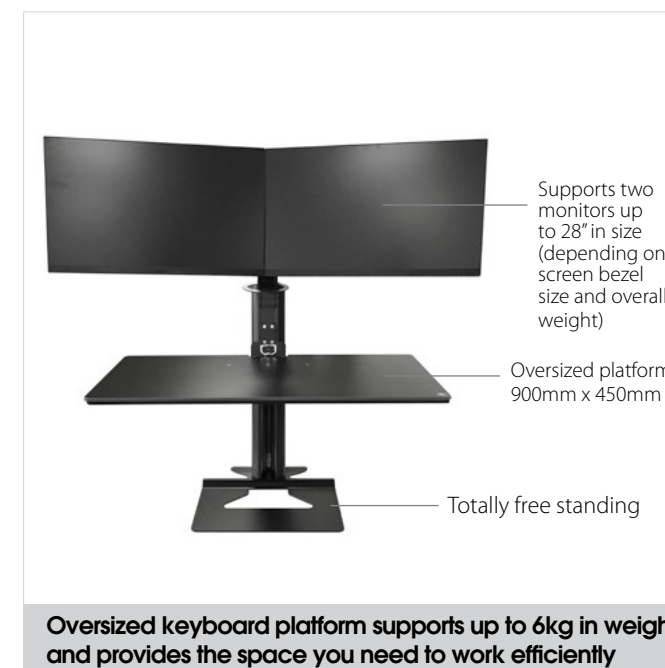

CODE	DESCRIPTION	ADJUSTABLE HEIGHT (mm)	MAX SCREEN WEIGHT (kg)	MAX PLATFORM WEIGHT (kg)	BLACK	WHITE	RSP (£)
SWD222	Metalicon i-stand dual screen unit	15 - 460mm (max lockable platform height)	8.5kg	6kg	•	•	£799



## SIT-STAND MATS

## COMFORT PU

## Anti-fatigue mat

The thin commercial carpets in most offices may look attractive, but do nothing much to cushion the hard floor beneath, so we have created a group of products specifically designed for sit-stand desks on hard office floors that aid health and productivity.

- › Anti-fatigue mat with soft PU cushioning
- › Reduces swelling of the legs
- › Decreases fatigue by improving circulation

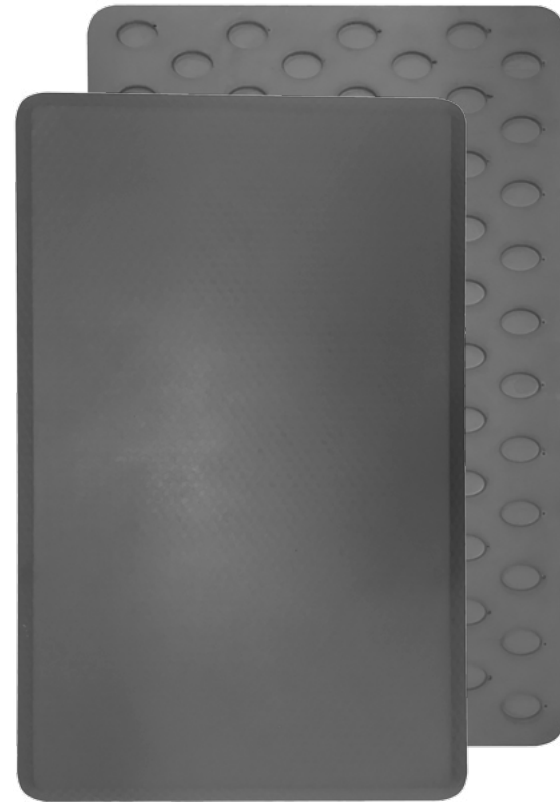

CODE	DESCRIPTION	DIMENSIONS (mm)	RSP (£)
AFMPU	Metalicon Comfy PU Anti-Fatigue Mat	w750 d480 h20	£89.00

## COMFORT SPOT

## Anti-fatigue mat

- › Elasticated, breathable structure
- › Reduces swelling of the legs
- › Decreases fatigue by improving circulation



Hanging clip included

To clean, just brush, vacuum or wash



› Comes with hanging clip, compatible with any desktop

CODE	DESCRIPTION	DIMENSIONS (mm)	RSP (£)
AFMCS	Metalicon Comfort Spot Anti-Fatigue Mat	w640 d460 h30	£145.00

## SIT-STAND MATS

## BALANCE BOARD

## Its never too late to skate

As you stand on the Balance board your body will instinctively make constant tiny movements so you maintain your equilibrium. This is incredibly beneficial for your health in numerous ways; for example:

- › Activates and tones muscles in your back, core, legs and ankles
- › Boosts the metabolism increasing alertness and calorie consumption
- › Increased alertness means increased productivity
- › Make long term improvements to ease of movement in your joints, balance, reaction times, core strength and general flexibility and well being
- › Improve your appearance with toned calf and leg muscles
- › Activates use of the pelvic area with its unique skateboard-like pivot design, which aids in helping maintaining good normal posture of the neck, shoulders, and back

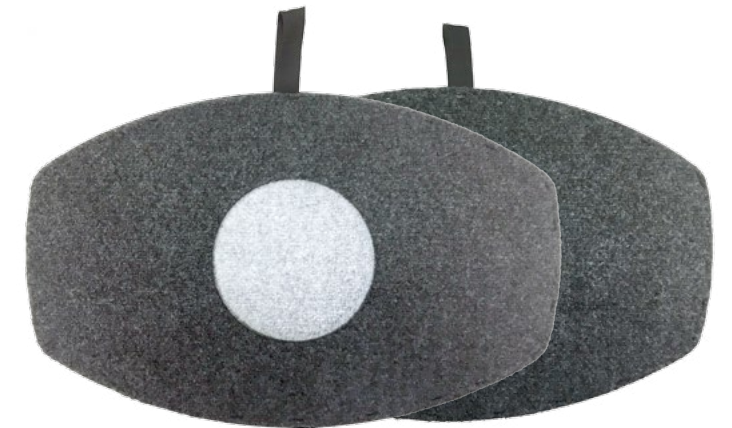

› Comes with hanging clip, compatible with any desktop



To clean, just brush, vacuum or wash with water

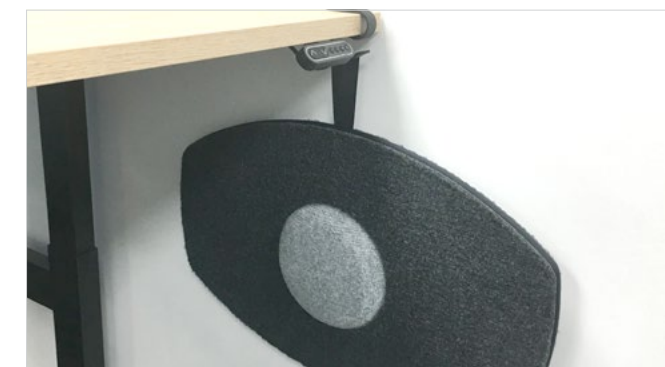

Hanging clip included



Minimises the feeling of weight in your body

CODE	DESCRIPTION	DIMENSIONS (mm)	RSP (£)
AFMBB	Metalicon Balance Board Sit-Stand Mat	w600 d400 h60	£269.00



# STEEL PEDESTALS

## CUBE

### Premium steel pedestals

- › Narrow and classic widths
- › Available in anthracite, black, silver and white
- › Range of standard, low and narrow sizes
- › Includes pen tray and drawer dividers
- › Hidden castors (supplied fitted)
- › Four locking castors
- › Central locking
- › Full box file drawer



CUBE Pedestal RAL colour codes: White: 9016 | Silver: 9006 | Anthracite: 7016 | Black: 9017



Slim top & flat front design

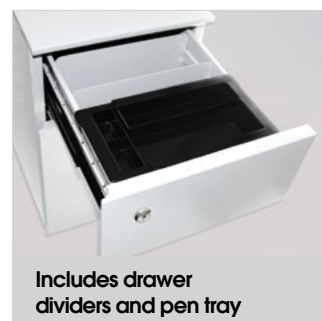

Includes drawer dividers and pen tray



Soft close drawer runners



Smoky Black finish option

CODE	DESCRIPTION	W (mm)	D (mm)	H (mm)	SMOKE	ANTHRACITE	BLACK	SILVER	WHITE	RSP (€)
PMS3530	Narrow Low Mobile Pedestal 3 Personal drawers	300	500	495					•	£205.00
PMS3511	Narrow Low Mobile Pedestal 1 Personal drawer 1 File drawer	300	500	495				•	•	£199.00
PMS3521	Narrow Mobile Pedestal 2 Personal drawers 1 File drawer	300	500	597	•	•	•	•	•	£225.00
PMS4530	Low Mobile Pedestal 3 Personal drawers	410	500	495					•	£225.00
PMS4511	Low Mobile Pedestal 1 Personal drawer 1 File drawer	410	500	495				•	•	£215.00
PMS4521	Mobile Pedestal 2 Personal drawers 1 File drawer	410	500	597	•	•	•	•	•	£239.00

# STEEL PEDESTALS

## SPECTRUM

### Show your colours

- › Unique inset frame and handle design
- › White handles supplied as standard
- › Upgrade to a choice of 6 standard handle stock colours (see below) or specify any K5 classic RAL colour (200+)
- › Includes pen tray and drawer dividers
- › All built to same premium specifications as CUBE pedestals



Choose any RAL colour



Pictured: Left hand version

Caddy - Combined pedestal and cupboard - LH and RH available

CODE	DESCRIPTION	W (mm)	D (mm)	H (mm)	CARCASS COLOUR	STD HANDLE COLOUR	RSP (€)
SMS3521	Steel Narrow Mobile Pedestal 2 Personal drawers 1 File drawer	300	500	597	White	White	£235.00
SMS4521	Steel Mobile Pedestal 2 Personal drawers 1 File drawer	410	500	597	White	White	£249.00
SMC9521L	Steel Mobile Caddy Unit 2 Personal Drawers 1 File Drawer 2 Shelf Tambour Cupboard (LH)	900	480	645	White	White	£499.00
SMC9521R	Steel Mobile Caddy Unit 2 Personal Drawers 1 File Drawer 2 Shelf Tambour Cupboard (RH)	900	480	645	White	White	£499.00
SHSTC3	Set of 3 Replacement Handles in Standard Colours (Black, Orange, Red, Blue, Green, Yellow)	N/A	N/A	N/A	N/A	N/A	£36.00
SHRAC3	Set of 3 Replacement Handles in RAL Colour (Minimum Quantities May Apply)	N/A	N/A	N/A	N/A	N/A	£49.00*

\*Estimated Price - SHRAC3 Handles in special colours are subject to individual quotation, dependent upon specific colour and quantity required



# CPU HOLDERS

Keep the desk clear and the CPU safe.

- › Mini versions for thin-client and small CPUs
- › Large versions for tower and older CPUs
- › C3 & C4 styles supplied almost fully assembled
- › Range certified to severe structural standards
- › Spring-loaded pin for easy height adjustment
- › Security bars featured on C3 and C4
- › Slide & turn unit locks in position to prevent unwanted movement



**C2 Large CPU holder**

- Easy spring-pull height adjustment
- Soft grip pads prevent scratches
- Use with C9 slide & turn adapter



**C3 Large CPU holder**

- Easy spring-pull height adjustment
- Desktop or side panel fixing
- Use with C9 slide & turn adapter
- Security bars prevent CPU accidentally falling from holder



**C4 Small CPU holder**

- Ideal for thin client and small CPU
- Easy adjustment with desktop fixing
- Use with C9 slide & turn adapter
- Security bars prevent CPU accidentally falling from holder



**C5 Mobile CPU holder**

- Soft grip pads prevent scratches
- Locking castors



**C6 Universal CPU holder**

- Black finish only
- Easy adjustment
- Either direct fix or with legs to clear desk underframe



C9 adapter pictured with optional CHSP spacers.

**C9 IS SUITABLE FOR USE WITH C2, C3 AND C4 CPU HOLDERS**

**C9 Universal Slide and Turn adapter available**

CODE	DESCRIPTION	ADJUSTABLE WIDTH (mm)	ADJUSTABLE HEIGHT (mm)	BLACK	SILVER	WHITE	RSP (\$)
CHF2311	C2 Large CPU holder for fixing to desk top	110 - 230	300 - 500	•	•	•	£64.00
CHF2208	C3 Large CPU holder for fixing to desk top	80 - 220	300 - 530	•	•	•	£79.00
CHF1104	C4 Mini CPU holder for fixing to desk top	35 - 115	205 - 360	•	•	•	£62.00
CHM2517	C5 Mobile CPU holder	170 - 250	N/A	•	•	•	£30.00
CHF2504	C6 Universal Adjustable Belt CPU holder	Adjustable strap	Adjustable strap	•	•	•	£36.00
CHFHMK	Horizontal Mounting Kit for use with CHF2504	N/A	N/A	•	•	•	£14.00
CHUST	C9 Slide and Turn Adapter	N/A	N/A	•	•	•	£49.00
CHSP	Desk beam clearance spacer	N/A	N/A	•	•	•	£8.00

# CPU HOLDERS

## C7 MICRO CPU HOLDER

For the new wave of micro office CPUs

- › Fits directly to Kardo arm with quick-release clamp height adjustment
- › 360° rotation for easy positioning
- › Ideal for mini CPUs
- › Fully adjustable for different CPU sizes
- › Can be fitted to pole or arm
- › Allows easy access to ports
- › Can also be fixed to any part of the desk



**FITS ANY 75MM VESA PLATE**



**C7 Fits any monitor arm VESA plate with 75mm spacing**

- Ideal for thin client and small CPU
- Hides CPU out of view behind the monitor
- Complete cable management with integration to Libero range
- Adjustable strap offers extra stability and protection
- Keeps ports open and easier to access



**C7 can be fitted to any surface**

- Can be fixed to any part of the desk or work surface.
- Adjustable strap holds CPU in place
- Soft grip pads prevent scratches

CODE	DESCRIPTION	ADJUSTABLE HEIGHT (mm)	ADJUSTABLE DEPTH (mm)	BLACK	SILVER	WHITE	RSP (\$)
CHV1002	C7 Micro CPU Holder	N/A	25 - 63	•	•	•	£39.00

## CABLE MANAGEMENT

The scourge of many an office workspace. Loose cables are unsightly and can be dangerous.

Solve the problem with one of our four Metalicon vertical cable managers, including the new VCS2 which offers improved insulation and movement as well as Snap Wrap with its revolutionary snap shut design.



Cable Management



VCS1 Vertical Cable Manager - Silver, White or Black

Code	Size (mm)	Price (£)
VCS1	w75 d35 h820	29



VCS2 Vertical Cable Manager - Silver, White or Black

Code	Size (mm)	Price (£)
VCS2	Ø70 h720 - 820	35

Ideal for sit/stand desks

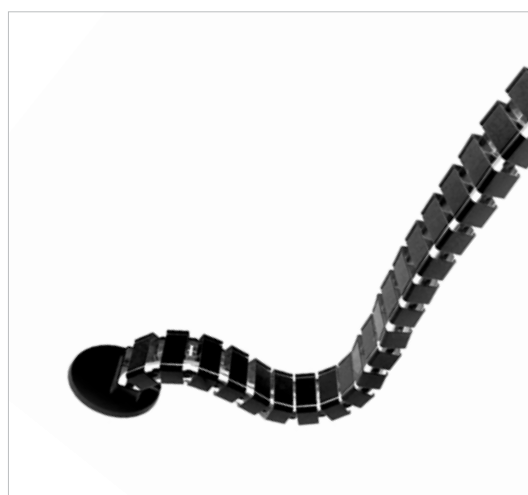

VCS3 Vertical Cable Manager for Sit/Stand Desks  
Black only. Silver or white on special order

Code	Size (mm)	Price (£)
VCS3	w68 d36 h1300	45



Snap Wrap Cable Manager for Sit/Stand Desks - Silver, White or Black

Code	Size (mm)	Price (£)
VCS080	800mm high	67
VCS150	1500mm high	109

## UNDER DESK POWER MODULES

Robust, value for money under desk power modules for installation in cable trays.

Power modules can be purchased with or without power leads. Modules can be linked in series with connector leads, with a maximum of 6 power sockets in one series.



Power Modules

UK individually fused 3.15A power sockets.

All power modules include 250mm trailing earth lead.

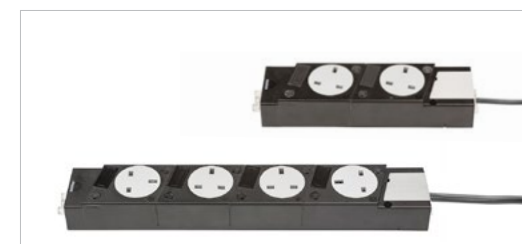

### Power Only - No leads

Code	Description	Price (£)
UPM-2P	2 power sockets	25
UPM-4P	4 power sockets	30
UPM-6P	6 power sockets	54

### Power Only - With leads

Code	Description	Price (£)		
		2m	3m	5m
UPM-2P	2 power sockets	38	40	46
UPM-4P	4 power sockets	42	44	51
UPM-6P	6 power sockets	66	69	75

### Power Only - With Switch(es), no leads

Code	Description	Price (£)
UPM-2P1N	2 power sockets, 1 switch	33
UPM-4P1N	4 power sockets, 1 switch	37

### Power Only - With Switch(es) and leads

Code	Description	Price (£)		
		2m	3m	5m
UPM-2P1N	2 power sockets 1 switch	45	47	54
UPM-4P1N	4 power sockets 1 switch	49	52	58

### Power Leads - Mains lead to 3 pole female connector

Code	Length	Price (£)
PL-UKWF/02	2m	12
PL-UKWF/03	3m	14
PL-UKWF/05	5m	20

### Connector Leads - 3 pole male to female connector

Code	Length	Price (£)
PL-WMWF/005	0.5m	7
PL-WMWF/010	1m	8
PL-WMWF/015	1.5m	10
PL-WMWF/020	2m	11
PL-WMWF/030	3m	14

Mains Power Leads

**Please note:**  
Only 6 additional power sockets can be daisy-chained from one 13A power source.

UK Plug configuration.



# DESKTOP POWER MODULES

High quality power modules for clamping to the back of desk tops.

Ideal for hot desking, phone chargers and more. They provide complete, customisable, individually fused power sockets and Cat6 data sockets in a stylish, versatile and space saving device. A free fixing clamp allows for use with static and sliding desk tops.



## Desk Mounted Power & Data Modules

With 800mm trailing lead to 3 pole connector.

USB, HDMI, VGA, Audio options also available - POA.

Available in Silver/White, Silver/Grey, Silver/Black.

Other socket combinations and options available.



### FREE mounting bracket included

Using the lightweight solid aluminium mounting bracket you can raise the power module off the desk top. The cleverly designed clamps supplied with each module tighten from below the unit using a standard hex key.



### 2 Mains Power Sockets only - Complete with power lead

Code	Lead Length	UK Sockets	Neon Switch	Cat6 Sockets	USB Charge	Price (€)
DPM2-2P1N/02	2m	2	1	-	-	95
DPM2-2P1N/03	3m	2	1	-	-	98
DPM2-2P1N/05	5m	2	1	-	-	105

### 2 Mains Power and 2 Data Sockets - Complete with power and data leads

Code	Lead Length	UK Sockets	Neon Switch	Cat6 Sockets	USB Charge	Price (€)
DPM2-2P1N2D/02	2m	2	1	2	-	144
DPM2-2P1N2D/03	3m	2	1	2	-	153
DPM2-2P1N2D/05	5m	2	1	2	-	164

### 2 Mains Power and 2 USB Charge Sockets - Complete with power lead

Code	Lead Length	UK Sockets	Neon Switch	Cat6 Sockets	USB Charge	Price (€)
DPM2-2P1N2C/02	2m	2	1	-	2	149
DPM2-2P1N2C/03	3m	2	1	-	2	152
DPM2-2P1N2C/05	5m	2	1	-	2	159

### 2 Mains Power, 2 Data and 2 USB Charge Sockets - Complete with power and data leads

Code	Lead Length	UK Sockets	Neon Switch	Cat6 Sockets	USB Charge	Price (€)
DPM2-2P1N2D2C/02	2m	2	1	2	2	206
DPM2-2P1N2D2C/03	3m	2	1	2	2	213
DPM2-2P1N2D2C/05	5m	2	1	2	2	223

### 4 Mains Power Sockets only - Complete with power lead

Code	Lead Length	UK Sockets	Neon Switch	Cat6 Sockets	USB Charge	Price (€)
DPM2-4P1N/02	2m	4	1	-	-	133
DPM2-4P1N/03	3m	4	1	-	-	136
DPM2-4P1N/05	5m	4	1	-	-	143

### 4 Mains Power and 2 USB Charge Sockets - Complete with power lead

Code	Lead Length	UK Sockets	Neon Switch	Cat6 Sockets	USB Charge	Price (€)
DPM2-4P1N2C/02	2m	4	1	-	2	201
DPM2-4P1N2C/03	3m	4	1	-	2	204
DPM2-4P1N2C/05	5m	4	1	-	2	211

# POWERONE POWER MODULES FOR 80MM CABLE PORT

This innovative product makes use of the frequently vacant cable ports within desks.

Powerone with power, data, HDMI and USB smart charging are now available with round and square tops and in a range of colour choices.

## Powerone Desk Insert Modules

CUSTOM FINISHES AVAILABLE

Our stocked colour options are black, grey or white inserts with stainless steel surrounds in all black or all white. You can choose any RAL K5 classic colour on orders of 50 or more.

For smaller orders with custom colours, set-up fees apply.

Other socket combinations and custom finish options available, POA.



Picture: Custom finish Powerone module with power, HDMI and USB.

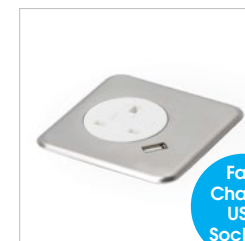

Fast Charge USB Sockets

Fast Charge USB Sockets

Fast Charge USB Socket

Fast Charge USB Socket

### 1 Power Socket - Complete with power lead

Code	Lead Length	UK Sockets	HDMI Socket	Data Sockets	Smart Charge USB	Price (€)
P1DG-1P/02	2m	1	-	-	-	90
P1DG-1P/03	3m	1	-	-	-	93
P1DG-1P/05	5m	1	-	-	-	101

### 1 Power, 1 HDMI and 1 Data Socket - Complete with power/data leads

Code	Lead Length	UK Sockets	Neon Switch	Data Sockets	Smart Charge USB	HDMI SVGA	Cat 5e Price (€)	Cat 6 Price (€)
P1DG-1P1D/02	2m	1	-	1	-	-	109	113
P1DG-1P1D/03	3m	1	-	1	-	-	117	121
P1DG-1P1D/05	5m	1	-	1	-	-	137	142

### 1 Power and 1 Smart Charge USB Socket - Complete with power lead

Code	Lead Length	UK Sockets	HDMI Socket	Data Sockets	Smart Charge USB	Price (€)
P1DG-1P1C/02	2m	1	-	-	1	132
P1DG-1P1C/03	3m	1	-	-	1	138
P1DG-1P1C/05	5m	1	-	-	1	142

### 1 Power and 2 Smart Charge USB Sockets - Complete with power leads

Code	Lead Length	UK Sockets	HDMI Socket	Data Sockets	Smart Charge USB	Price (€)
P1DG-1P2C/02	2m	1	-	-	2	147
P1DG-1P2C/03	3m	1	-	-	2	151
P1DG-1P2C/05	5m	1	-	-	2	158

### 1 Power, 1 Data and 1 Smart Charge USB Socket - Complete with power/data leads

Code	Lead Length	UK Sockets	Neon Switch	Data Sockets	Smart Charge USB	HDMI SVGA	Cat 5e Price (€)	Cat 6 Price (€)
P1DG-1P1D1C/02	2m	1	-	1	-	-	141	146
P1DG-1P1D1C/03	3m	1	-	1	-	-	149	154
P1DG-1P1D1C/05	5m	1	-	1	-	-	165	170

### 1 Power, 1 HDMI and 1 Smart Charge USB Socket - Complete with power/data leads

Code	Lead Length	UK Sockets	HDMI Socket	Data Sockets	Smart Charge USB	Price (€)
P1DG-1P1H1C/02	2m	1	1	-	1	159
P1DG-1P1H1C/03	3m	1	1	-	1	171
P1DG-1P1H1C/05	5m	1	1	-	1	192

### 1 Power, 1 HDMI and 1 Data Socket - Complete with power/data leads

Code	Lead Length	UK Sockets	Neon Switch	Data Sockets	Smart Charge USB	HDMI SVGA	Cat 5e Price (€)	Cat 6 Price (€)
P1DG-1P1H1D/02	2m	1	-	1	-	1	159	164
P1DG-1P1H1D/03	3m	1	-	1	-	1	171	176
P1DG-1P1H1D/05	5m	1	-	1	-	1	192	197

Product images for illustrative purposes only. Choose any stock combination of round or square stainless steel, black ABS or white ABS surrounds, with any combination of power/data port colours in matching stainless steel, black or white ABS.

# DESK INSERT POWER & DATA MODULES

Get power and data delivered at your fingertips with our range of desk inserts.

Discrete power modules designed for aesthetically pleasing work and meeting places.

Power/data leads are always included in the price, other port combinations of power and data as well as USB, HDMI, audio and VGA are available - POA.



## Touch-To-Rotate



\*Power/data leads and 500mm drop lead to 3 pole connector are included in all prices.

Other power/data combinations and USB, HDMI, VGA and audio options also available - POA

Available in silver/light grey, all white and all black. Other lengths of power lead available - POA.



Smart Charge USB Sockets



Smart Charge USB Sockets



Smart Charge USB Sockets

### 2 Mains Power Sockets Only\*

Code	Lead Length	UK Sockets	Neon Switch	Data Sockets	Smart Charge USB	HDMI	SVGA	Price (£)
TTR-2P/02	2m	2	-	-	-	-	-	369
TTR-2P/03	3m	2	-	-	-	-	-	371
TTR-2P/05	5m	2	-	-	-	-	-	378

\*Complete with power lead

### 2 Mains Power and 2 USB Smart Charge Sockets\*

Code	Lead Length	UK Sockets	Neon Switch	Data Sockets	Smart Charge USB	HDMI	SVGA	Price (£)
TTR-2P2C/02	2m	2	-	-	2	-	-	518
TTR-2P2C/03	3m	2	-	-	2	-	-	521
TTR-2P2C/05	5m	2	-	-	2	-	-	527

\*Complete with power lead

### 2 Mains Power and 2 Data Sockets\*

Code	Lead Length	UK Sockets	Neon Switch	Data Sockets	Smart Charge USB	HDMI	SVGA	Cat 5e Price (£)	Cat 6 Price (£)
TTR-2P2D/02	2m	2	-	2	-	-	-	393	405
TTR-2P2D/03	3m	2	-	2	-	-	-	400	410
TTR-2P2D/05	5m	2	-	2	-	-	-	410	424

\*Complete with power/data leads

### 2 Mains Power, 2 Data and Dual Smart Charge USB sockets\*

Code	Lead Length	UK Sockets	Neon Switch	Data Sockets	Smart Charge USB	HDMI	SVGA	Cat 5e Price (£)	Cat 6 Price (£)
TTR-2P2D2C/02	2m	2	-	2	2	-	-	542	555
TTR-2P2D2C/03	3m	2	-	2	2	-	-	549	559
TTR-2P2D2C/05	5m	2	-	2	2	-	-	560	573

\*Complete with power/data leads

### 2 Mains Power Sockets Only - Complete with power lead

Code	Lead Length	UK Sockets	Smart Charge USB	Data Sockets	Price (£)
FPM-2P/02	2m	2	-	-	186
FPM-2P/03	3m	2	-	-	189
FPM-2P/05	5m	2	-	-	195

### 2 Mains Power and 2 USB Smart Charge Sockets - Complete with leads

Code	Lead Length	UK Sockets	Smart Charge USB	Data Sockets	Price (£)
FPM-2P2C/02	2m	2	2	-	317
FPM-2P2C/03	3m	2	2	-	320
FPM-2P2C/05	5m	2	2	-	326

## Aspect Desk Inserts



Includes 500mm Lead to 3 Pole Connector. USB, HDMI, VGA, Audio options also available - POA.

All items available in Silver/Light Grey. Units also available in all white and black. Other lengths of power lead available - POA.



# DESK INSERT POWER & DATA MODULES

## Aspect Desk Inserts



Includes 500mm Lead to 3 Pole Connector. USB, HDMI, VGA, Audio options also available - POA.

All items available in Silver/Light Grey. Units also available in all white and black. Other lengths of power lead available - POA.



### 2 Mains Power and Data Sockets - Complete with leads (neon switch option available - POA)

Code	Lead Length	UK Sockets	Neon Switch	Data Sockets	Cat 5e Price (£)	Cat 6 Price (£)
FPM-2P2D/02	2m	2	-	2	199	212
FPM-2P2D/03	3m	2	-	2	207	217
FPM-2P2D/05	5m	2	-	2	217	231

### 2 USB Smart Charging Sockets, 2 Mains Power and Data Sockets - Complete with leads

Code	Lead Length	UK Sockets	Smart Charge USB	Data Sockets	Cat 5e Price (£)	Cat 6 Price (£)
FPM-2P2D2C/02	2m	2	2	2	326	339
FPM-2P2D2C/03	3m	2	2	2	334	344
FPM-2P2D2C/05	5m	2	2	2	344	358

### 2 Mains Power Sockets Only - Complete with power lead

Code	Lead Length	UK Sockets	Neon Switch	Data Sockets	Smart Charge USB	HDMI	SVGA	Price (£)
OPM-2P/02	2m	2	-	-	-	-	-	102
OPM-2P/03	3m	2	-	-	-	-	-	105
OPM-2P/05	5m	2	-	-	-	-	-	111

### 2 Mains Power Sockets and 2 USB Smart Charge Sockets - Complete with power lead

Code	Lead Length	UK Sockets	Neon Switch	Data Sockets	Smart Charge USB	HDMI	SVGA	Price (£)
OPM-2P2C/02	2m	2	-	-	2	-	-	195
OPM-2P2C/03	3m	2	-	-	2	-	-	198
OPM-2P2C/05	5m	2	-	-	2	-	-	204

### 2 Mains Power and 2 Data Sockets - Complete with power/data leads

Code	Lead Length	UK Sockets	Neon Switch	Data Sockets	Smart Charge USB	HDMI	SVGA	Cat 5e Price (£)	Cat 6 Price (£)
OPM-2P2D/02	2m	2	-	2	-	-	-	122	134
OPM-2P2D/03	3m	2	-	2	-	-	-	129	139
OPM-2P2D/05	5m	2	-	2	-	-	-	139	153

### 2 Mains Power, 2 Data and Dual Smart Charge USB sockets - Complete with power/data leads

Code	Lead Length	UK Sockets	Neon Switch	Data Sockets	Smart Charge USB	HDMI	SVGA	Cat 5e Price (£)	Cat 6 Price (£)
OPM-2P2D2C/02	2m	2	-	2	2	-	-	215	227
OPM-2P2D2C/03	3m	2	-	2	2	-	-	222	232
OPM-2P2D2C/05	5m	2	-	2	2	-	-	232	246

## Open Desk Inserts



Includes 500mm Lead to 3 Pole Connector.

USB, HDMI, VGA, Audio options also available - POA

Available in Silver/Light Grey, Silver/White.



Smart Charge USB Sockets





# WOOD, METAL AND LEATHER FINISHES

Choose from the following options to suit your office environment.

Colours are a printed representation and may vary slightly to actual finish. Samples of all materials are available on request.



## MFC Group 1

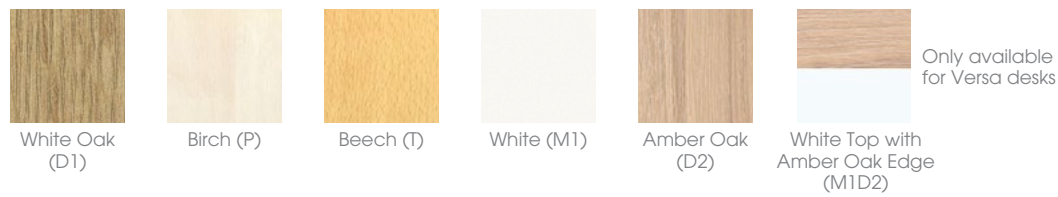

## MFC Group 2



## HPL Group 1



## HPL Group 2

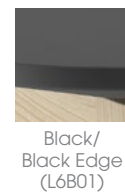

## Veneer



## Metal



## Leather Look

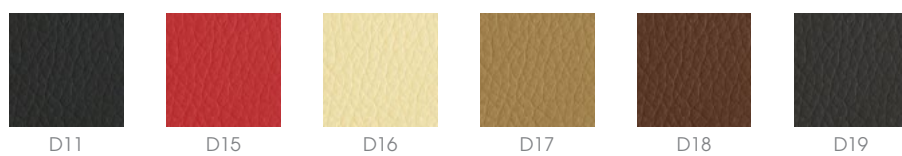

# VERSACOLOUR™ PERSPEX® RANGE



## Transparent Colours (Group 1)

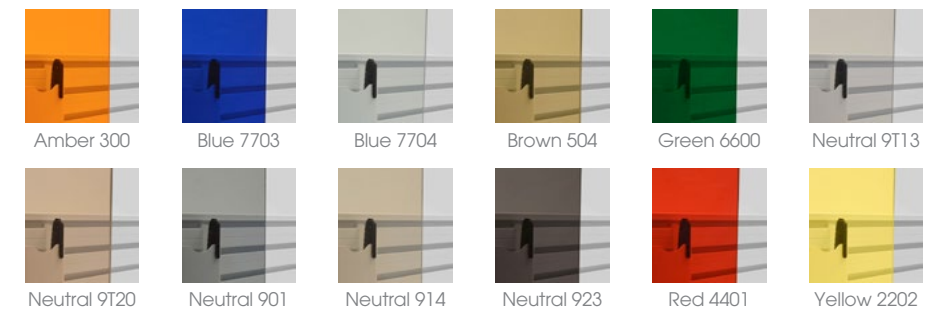

FREE Versacolor Perspex swatch

All registered Formetiq and Metalicon dealers qualify for a free Versacolor perspex swatch.

Visit [formetiq.com/swatch](http://formetiq.com/swatch) to find out more.

## Solid & Translucent Colours (Group 1)



## Perspex® Frost / Fluorescent (Group 2)

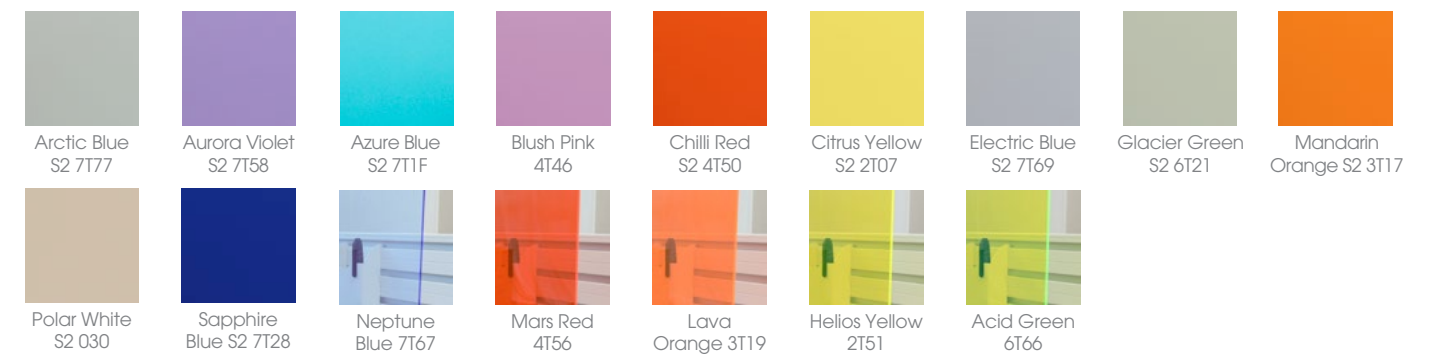

## Naturals (Group 2)

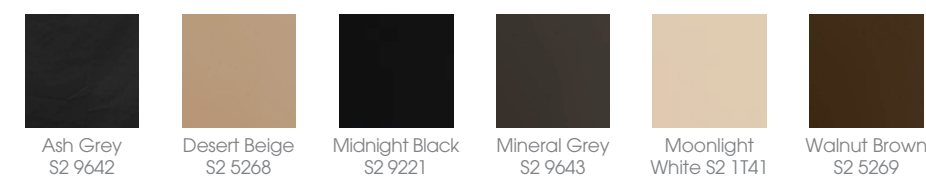

## Solid Black (Group 1)

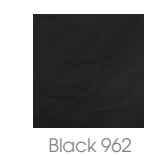

## Vario (Group 2)



## Clear/Glass Look (Group 1)

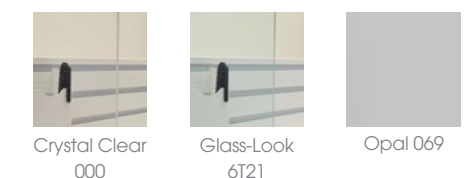

## FABRIC OPTIONS

The fabrics which adorn our products are used in a vast array of commercial interiors, education, healthcare and retail spaces.

They are tried, tested and certified to be safe and produce long lasting, comfortable and beautiful results which bring colour, design and personality to interior workspaces.



### Velito Presto Screen & Panel Fabric

With its composition of 88% pure wool and 12% PA, Velito Presto fabric is naturally resistant to dirt and fire as well as being antistatic.

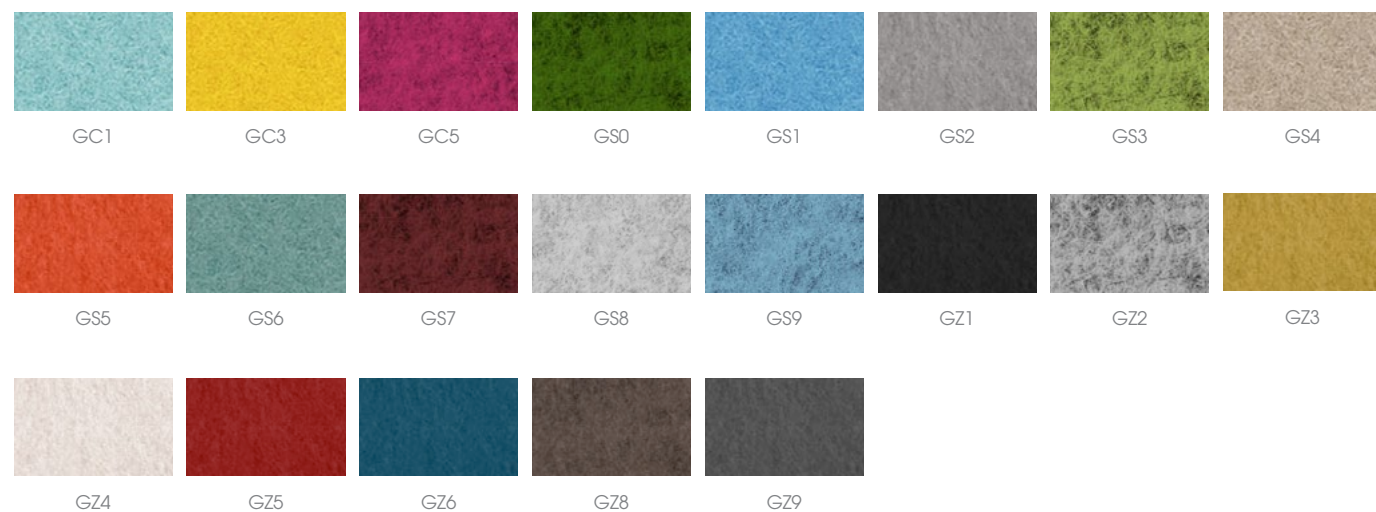

### Camira Lucia Screen & Panel Fabric

Camira Lucia is a crêpe weave synthetic panel fabric made using 100% recycled polyester. Its bold and bright colour palette and acoustic transparency are the perfect combination for our screen and panel products.



## FABRIC OPTIONS

### Camira Cara Screen Fabric

Cara is a plain weave screen/panel fabric available in a wide selection of commercial colourways. One of our most popular vertical surface fabrics, Cara is used extensively on desk screens, wallsides and on pin boards.

This fabric is largely acoustically transparent and as such is ideal to be used as a decorative facing for sound absorbing boards.



### Camira Xtreme Chair Fabric

Camira Xtreme is a modern crepe weave fabric made from 100% recycled polyester, diverting waste from landfill and saving virgin raw materials.

Its elastic properties, coupled with inherent flame resistance, durability and non-pilling properties make Xtreme an ever popular fabric for task chair seating.





## FABRIC OPTIONS

### Bondai Chair Fabric

Our Bondai chair fabric is 100% Polyester and weighs 350g/ml or 250g/m<sup>2</sup>.

It is fire resistant to industry standards, has an abrasion resistance rating of 150.000 rubs and comes with a 5 year warranty.

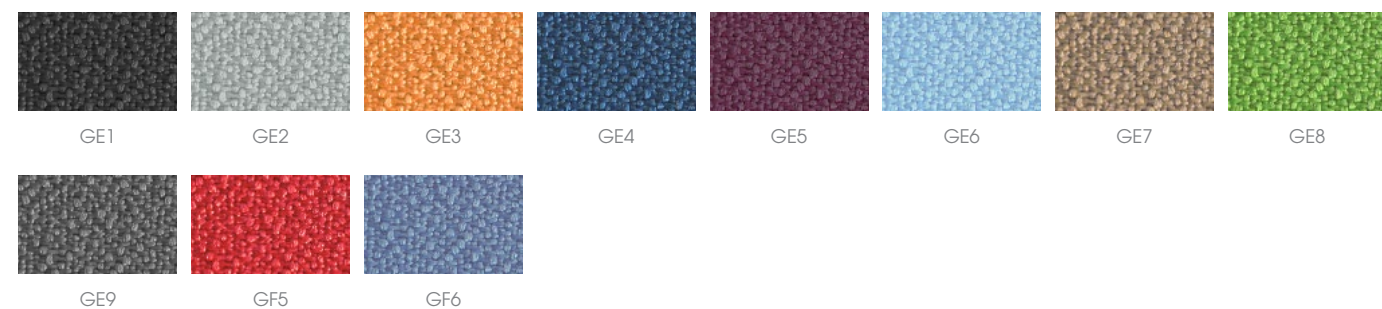

### Velito Chair Fabric

With its composition of 88% pure wool and 12% PA, Velito chair fabric is naturally resistant to dirt and fire as well as being antistatic.

Velito weighs in at 400 g/m<sup>2</sup> with an abrasion resistance of 120,000 rubs.

Its fastness to rubbing (pilling) rating is EN ISO 105x12, 4 (7000 cycles).

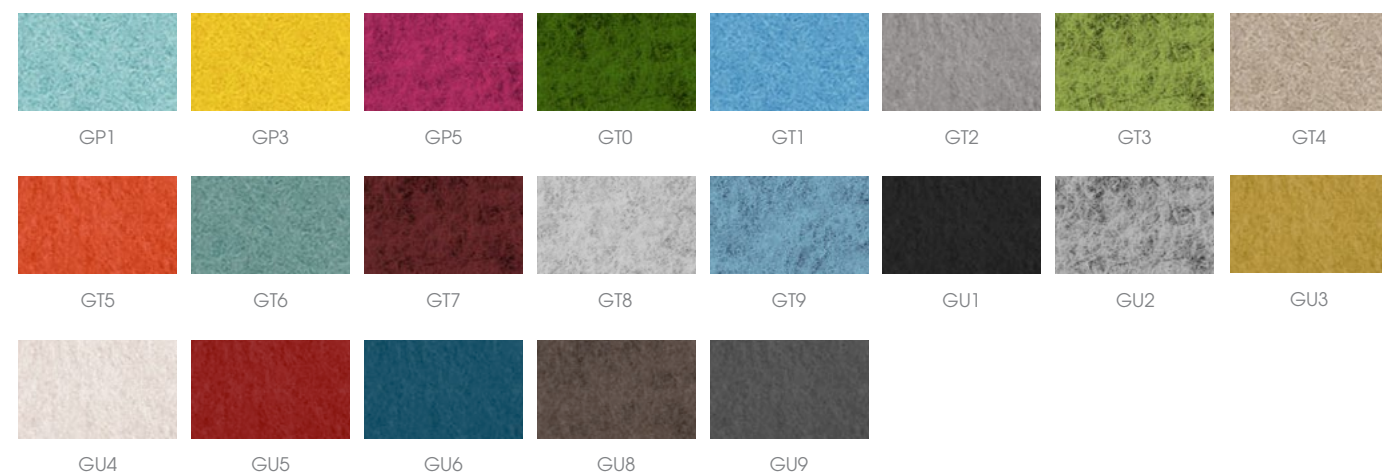

## FABRIC OPTIONS

### Berta Chair Fabric for Valencia Seating Range

Our Berta fabric is specially selected for the Valencia seating range.

Berta is made from 100% Polyester weighing 302g/m<sup>2</sup>. It has an abrasion resistance of 100.000 Martindale cycles and is certified non-flammable against BS EN 1021 - 1 (cigarette) and BS EN 1021 - 2 (match).

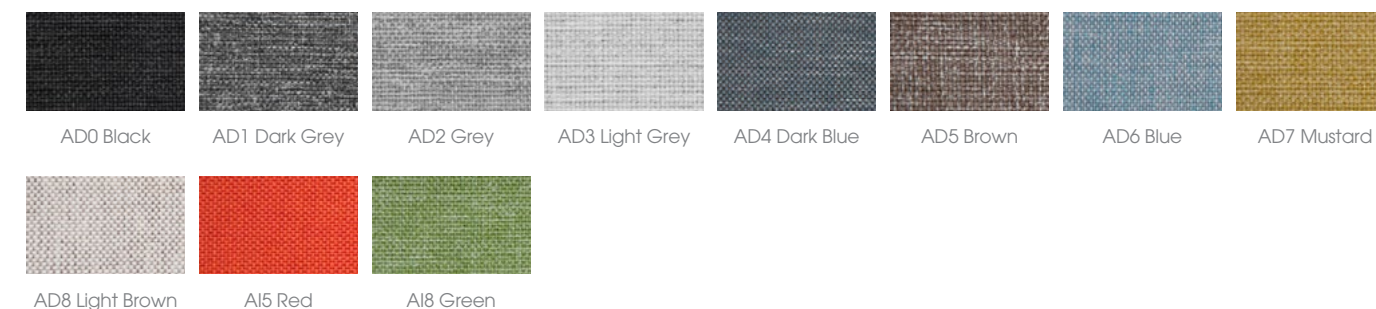

### Camira Synergy Chair/Screen Fabric

Say hello to Synergy, a soft handle wool blend fabric, featuring exquisite fibre dyed shades and sumptuous piece dyed solids.

Synergy's heart and soul comes from premium New Zealand wool, used in the woollen spun weft in combination with a fine worsted warp. This gives a smoother finish, softer still from the gentle milling process, the closer surface crop and the light pressing the fabric goes through. The refined finished cloth combines beautifully relaxed drape with sublime handle, yet achieves 100,000 Martindale abrasion cycles thanks to the inclusion of just 5% polyamide in the overall composition.

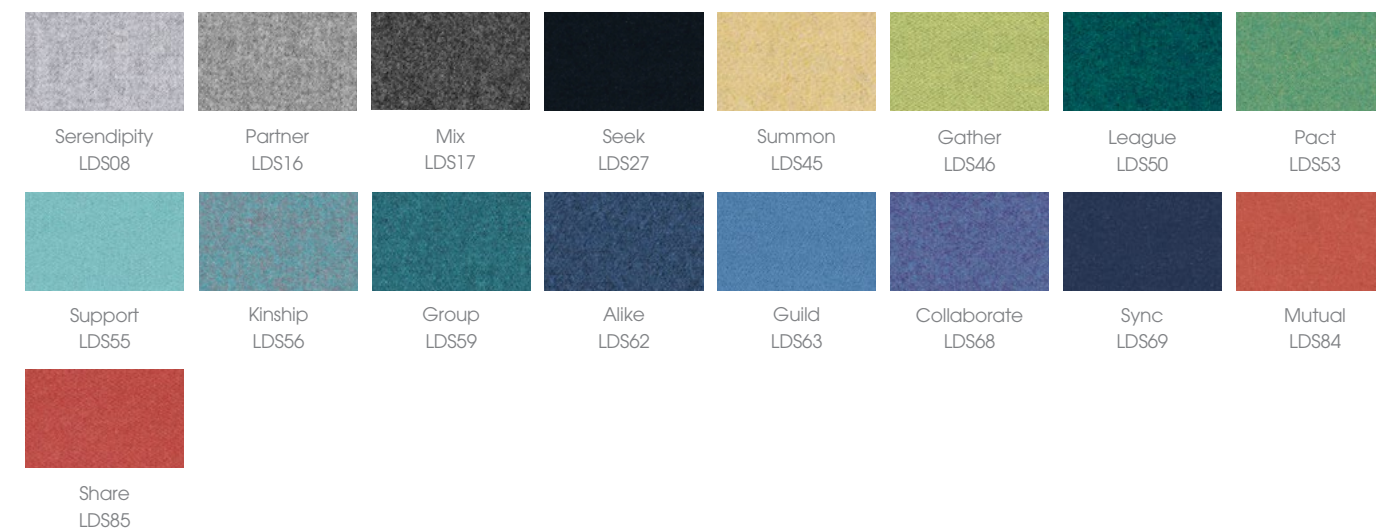







WORKSPACE  
INTELLIGENT WORKSPACES

**IQ WORKSPACE** | WALSTAN HOUSE, BARNARD ROAD, NORWICH, NORFOLK, NR5 9JB  
TEL: 01603 670 701 | EMAIL: SALES@IQWORKSPACE.CO.UK